



TITANIUM SIGNATURE SERIES INSTALLATION MANUAL

ALL 1/2" FUEL PORTS



APPLICATION:

TS-D08-100G
(100GPH @ 16-18PSI)
TS-D08-165G
(165GPH @ 16-18PSI)

**CUMMINS 5.9L 24
VALVE**

1998.5-2004

***NOTE: CAB AND
CHASSIS MAY REQUIRE
MODIFICATIONS**

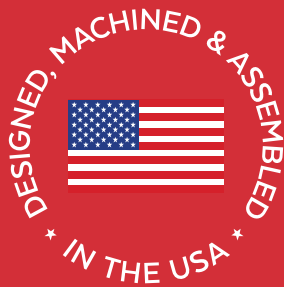



www.fassride.com

(866) 769.3747

Thank you for choosing FASS, from Diesel Performance Products, Inc.

FASS specializes in building extremely high-quality fuel products. We have earned an unsurpassed reputation for excellence in our industry by using only the highest-quality American-made components. In order to support our American workers and our American economy, more than 98+ percent of our products are manufactured completely in the United States.

Of course, that dedication to excellence comes at a price, but it is important to remember that price does not dictate quality—quality dictates price! We will never compromise by using cheaper, foreign-made components, like so many of our competitors do.

Customer satisfaction is our top priority and we strive always to provide outstanding customer service. Our Research and Development department, in conjunction with our Dealer Support Department, continually searches for ways to improve quality, expand our product line, and provide superb support. Our exclusive ViP Network ensures that customers receive the proper products and support at the local level. The extended four-year warranty is only available on products purchased from the network. There is no warranty on products not purchased outside the network.

IMPORTANT:

In order to qualify for the Lifetime extended warranty, your product registration form and proof of purchase from an authorized dealer must be submitted to FASS Fuel Systems within 30 days of purchase. Failure to comply will void the warranty. We have the right to deny any warranty believed to be false, altered or purchased through an unauthorized or terminated dealer. A current list of authorized dealers can be found on our website, FASSRide.com.

The complete conditions of the Limitation of Warranty can be found in the back of this manual, and FASSRide.com.

The installation of this product indicates that the buyer has read and understands the Warranty agreement and accepts its terms and conditions. In the event that the buyer does not agree with the terms, the product—in new, unused condition—along with the dated receipt should be returned within thirty (30) days of the date of purchase for a full refund less shipping costs.

**For more information,
contact Technical Support:
Diesel Performance Products, Inc.
16234 State Hwy O
Marthasville, MO 63357
636-433-5410**



WARNING!

This product has **NO WARRANTY** unless:

1. It has been purchased from an **Authorized** or **ViP FASS Dealer**. If in doubt, check **www.FASSRide.com**. (If your purchase was made on Amazon.com, the warranty is void. Return the FASS product to the seller and get a refund).
2. It is registered within thirty (30) days of purchase.

Other conditions may apply. Please see full warranty information.

ATTENTION!

Before you begin installation

Register for your Warranty ONLINE at

<https://www.fassride.com/register-a-warranty/>

No online access, call our TECH Support at

1-866-769-3747

FOLLOW THESE STEPS TO ENSURE A SIMPLE, CORRECT INSTALLATION OF YOUR NEW TITANIUM FUEL SYSTEM

ATTENTION:

Be sure to identify the proper FASS System and fuel line configuration. For help, our product finder can be found at www.FASSride.com. Follow the instructions to see fuel line detail.

- 1** Be sure the serial number on this installation manual matches that on the outside of the box.
- 2** Pay close attention to ALL WARNINGS
- 3** Read all instructions before starting installation of this product.
- 4** Inventory the package components. Notify the place of purchase immediately of any parts missing or damaged.
- 5** The installation recommendations contained herein are guidelines. Use good judgment and take into consideration your vehicles' accessories.
- 6** For best results in accuracy and efficiency (due to training, communication, and our relationship with our dealer network), we recommend a VIP FASS dealer for the installation. They are prepared to install the FASS fuel pumps with the most efficiency. If a situation or problem arises during the installation, the dealer is prepared to handle it. Diesel Performance Products, Inc. is not responsible for any installation mistakes.
- 7** If you have any questions or concerns that cannot be addressed with your dealer, email or call FASS.

**If any installation procedure is uncertain, contact FASS technical support.
Call customer service at 636-433-5410,
or send us an e-mail: techsupport@FASSride.com
with the following information:**

Your name, address and daytime phone number
Model (TS-D08-100G) or (TS-D08-165G) Serial
Number
Last 6 digits of vehicles' VIN

Date of purchase
Nature of Your Concern
Serial number



INSTALLATION MANUAL

TS-D08-100G or TS-D08-165G

(Installation Videos are available at www.fassride.com)

Recommended Application

TS-D08-100G: Cummins 1998.5-2004 with stock - 600 horsepower

TS-D08-165G: Cummins 1998.5-2004 with 600 - 900 horsepower

- 1. Read all instructions before starting installation of this product!**
- 2. Installing the improper FASS Pump can cause severe engine damage.**
- 3. Secure vehicle from ROLLING!**
- 4. Cab and Chassis may require modifications**
- 5. Consult vehicle's manufacturers' instructions concerning the electrical system before attempting any electrical connections.**
- 6. Be sure that the serial # on this installation manual matches that of the outside of the box.**
- 7. Flush and clean all brass fittings and fuel line from debris.**
- 8. Keep debris from entering the internals of the system during installation. Getting debris in the water separator nipple can lock up the motor. If the motor does lock up from debris call FASS for technical assistance.**



- 9. Wear safety glasses when operating power tools such as drills and grinders or when using a punch or chisel.**
- 10. Properly secure lines to prevent chaffing.**

BEFORE STARTING THE INSTALLATION PROCESS LUBRICATE THE BED BOLT WITH WD-40 TO HELP WITH INSTALLATION

**TITANIUM
SIGNATURE SERIES
100 GPH or 165 GPH
16-18 psi (Approximately)**

Rear View



Front View

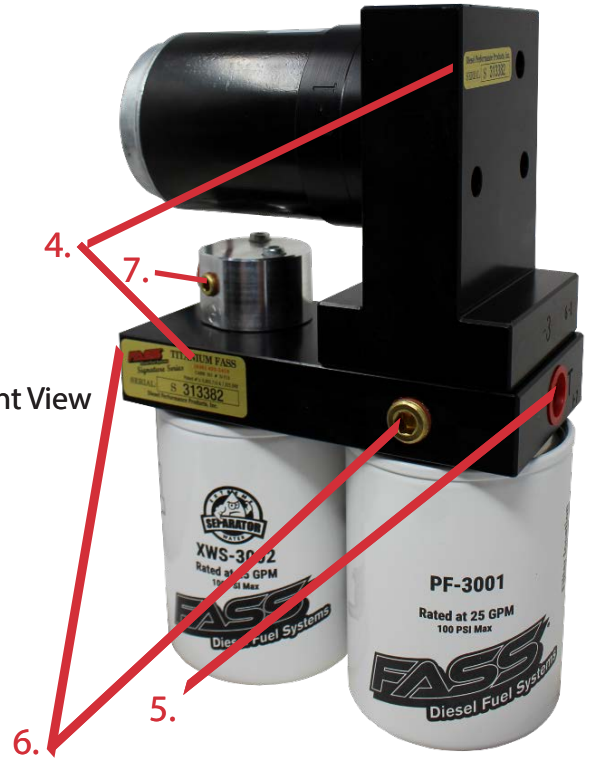

PUMP GUIDE:

- 1. "E" To Engine**
- 2. "R" Return to Tank**
- 3. "H" Coolant Heater Ports**
- 4. Serial Number**
- 5. "T" Fuel Inlet**
- 6. Electric Heater Ports**
- 7. "G" Gauge Port**

INSTALLATION GUIDE:

- Step 1. Install Electrical Harness**
- Step 2. Prep the FASS**
- Step 3. Mount the FASS**
- Step 4. Fuel Line Supply**
- Step 5. Review Installation**



www.fassride.com
(866) 769.3747

TITANIUM SIGNATURE SERIES 100 GPH or 165 GPH

16-18 psi (Approximately)
Note: Going over 30 PSI WILL void warranty.

**NOTE: WARRANTY MAY BE VOID IF SILICONE
BAND IS REMOVED FROM MOTOR!!**

*The silicone band is in place to retain motor
wires, preventing damage to the electric motor.*



CONTENTS

NOTE: Owner's Manual available for download on our website,
www.FASSride.com



RS-2001



DIELECTRIC GREASE



**TWO (2)
OR-017**



OR-030

NOTE: THESE SPARE BASE O-RINGS ARE INCLUDED WITH THE KIT IN THE EVENT OF A PINCHED O-RING DURING ASSEMBLY



MP-9020

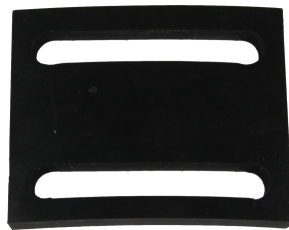

RS-2002



FL-1002 x17'



WH-1006-3



PBR-2001



PFB-2002

MOUNTING PACKAGE CONTENTS



TWO (2) RING TERMINAL



PL-2003

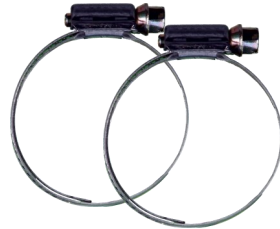

TWO (2) HC-1004



FOUR (4) LOCKING NUT 3/8"



THREE (3) WA-1001D



THREE (3) PL-1005



10-301



10-300



HC-1001



RM-1004



DIPF-1003



QD-1001



FOUR (4) Hex Bolt 3/8" -16x11/2"



THREE (3) HEX BOLT 1/4"-20x1 3/4"



FOUR (4) 3/8" WASHERS

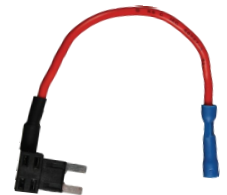

46044



46260

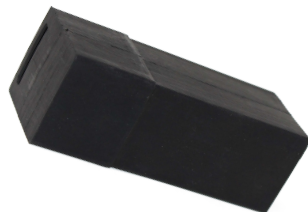

RELAY COVER

STEP 1:
INSTALL ELECTRICAL HARNESS

The installation of the electrical harness is done first, allowing power to be applied to the pump for lubrication purposes later in the installation.

**NOTE: USE SUPPLIED DIELECTRIC GREASE
SPARINGLY ON ALL ELECTRICAL
CONNECTIONS! BE SURE TO GREASE RELAY
PIGTAIL!**



STEP 1:
INSTALL ELECTRICAL HARNESS

The installation of the electrical harness is done first, allowing power to be applied to the pump for lubrication purposes later in the installation.

Install the Relay Cover onto the relay on the FASS harness.

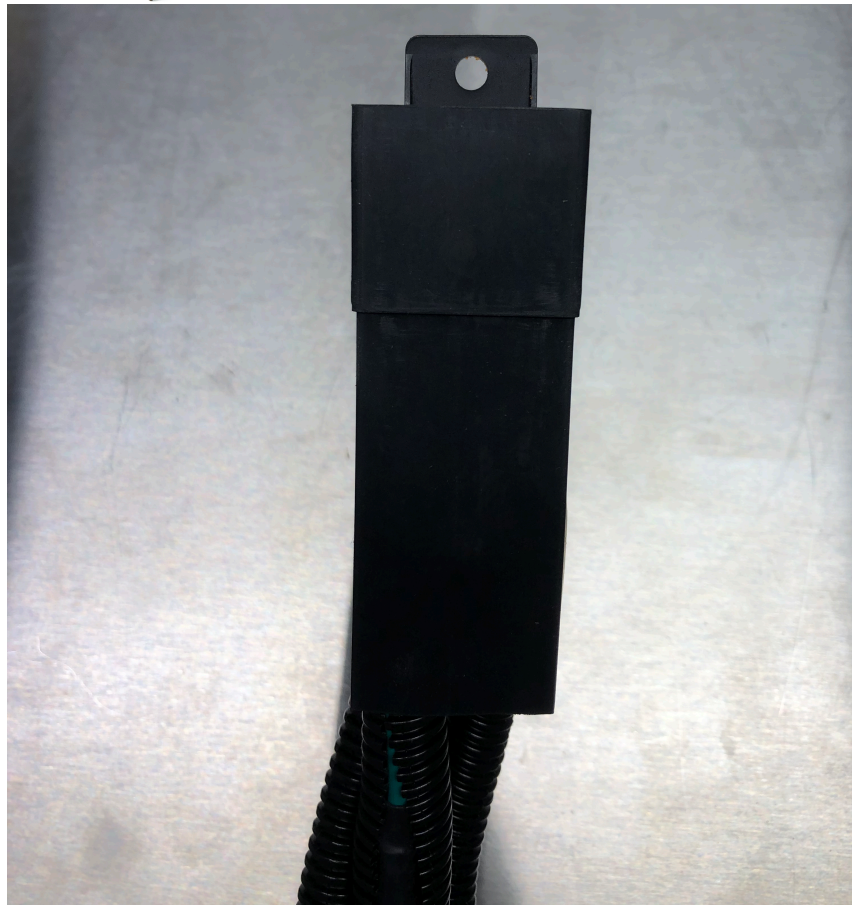

STEP 1:
INSTALL ELECTRICAL HARNESS

The installation of the electrical harness is done first, allowing power to be applied to the pump for lubrication purposes later in the installation.

**NOTE: BE SURE TO INSTALL THE SUPPLIED
10 AMP FUSE INTO THE FASS WIRING
HARNESS!!**



STEP 1: INSTALL ELECTRICAL HARNESS

The installation of the electrical harness should be completed first. This will allow power to be applied to the pump during installation.

- A. Using wire stripping tool remove excess insulation off the add-a-fuse and the WH-1006-3



- B. Place wire from 46044 and single red bare wire from WH-1006-3 into butt connector. Using crimping tool connect 46044 and WH-1006-3 with butt connector. Install 46260 to 46044 bottom slot (opening that is near the spade).

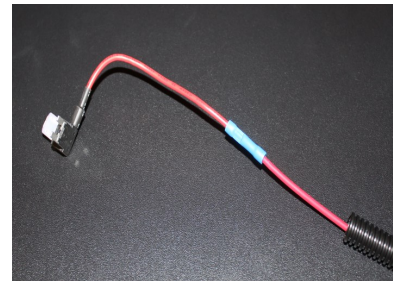
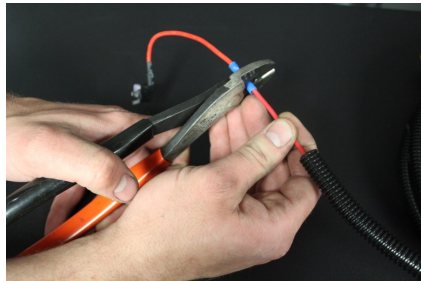
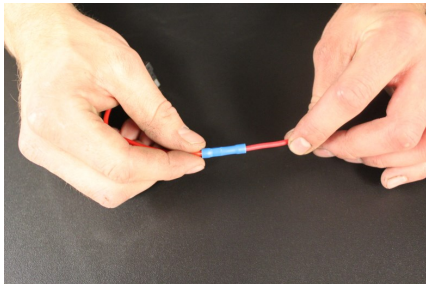

- C. Crimp the ring terminals to the red and green wires of the WH-1006-3 Wire Harness. Attach red wire to the positive terminal of the battery and the green terminal to the negative terminal. *The use of a corrosion preventative on electrical connections is recommended.*



STEP 1: **INSTALL ELECTRICAL HARNESS**

D. Secure relay and fuse in an upright position, as shown, to prevent moisture from entering. Di-electric grease may be applied to prevent corrosion.

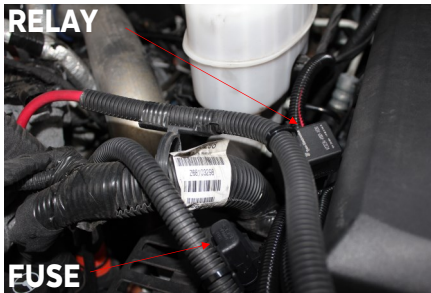

E. If fuse panel is located in the cab it will be necessary to guide the single red wire from the relay through the fire wall grommet to access the fuse panel.



F. Locate fuse box under hood and select ignition hot fuse. Remove fuse and put Add-A-Fuse in place. Install fuse previously removed. **The use of a corrosion preventative on electrical connections is recommended.**

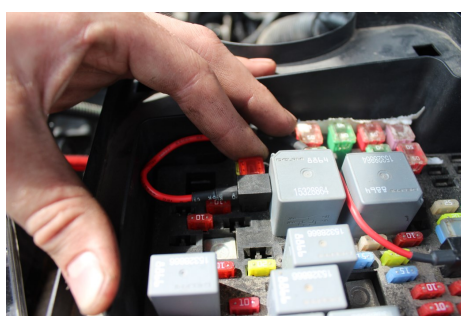
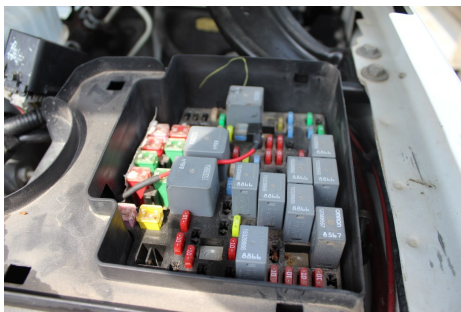



www.fassride.com
(866) 769.3747

STEP 1: ***INSTALL ELECTRICAL HARNESS***

G. Route WH-1006-3 wire harness along frame rail to mounting location of pump. **Completion of this step will be addressed in the Mounting Step 3.**

STEP 2: PREPARE SUCTION & RETURN LINES

Some of the photo's are of a different application, procedures are the same..

- A.** Prepare FASS return line by cutting rubber junction connecting the filler neck to the fuel tank.



- B.** Filler neck removed for clarity. Insert & position, into cut filler neck, RM-1004 with the junction pipe aiming to outside of bed. Clamp rubber and RM-1004 using both HC-1004's and factory clamps.

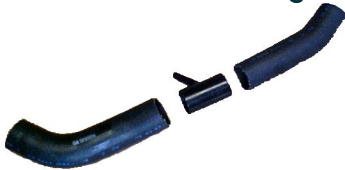

- C.** Using a HC-1001 connect FL-1002 Fuel Line to the junction of RM-1004.

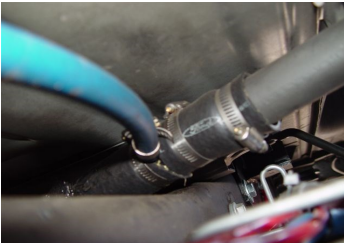

- D.** Using a hose clamp install fuel line over the knurled flare on the QD-1001. Oil O-rings inside Quick Disconnect.



Helpful Hint: If more space is required to access the top of the fuel tank, loosen the strap nuts to the end of the stud. This will gain you about 3" more working room. Bed has been removed for picture-clarity.

- E.** Disconnect factory suction line clip by pressing in on the two tabs located on either side in the connection fitting. Once removed, clean the suction tube and connect the QD-1001 addressed in the previous step. Loop fuel line over frame, will be addressed in step Installing Fuel Line. Plug or seal factory line or remove.

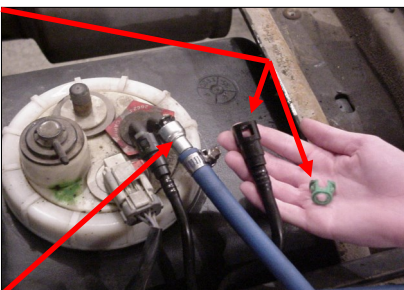

NOTE:

ATTENTION: While installing fittings into Titanium pump
DO NOT Apply side pressure to draw tube of pump p

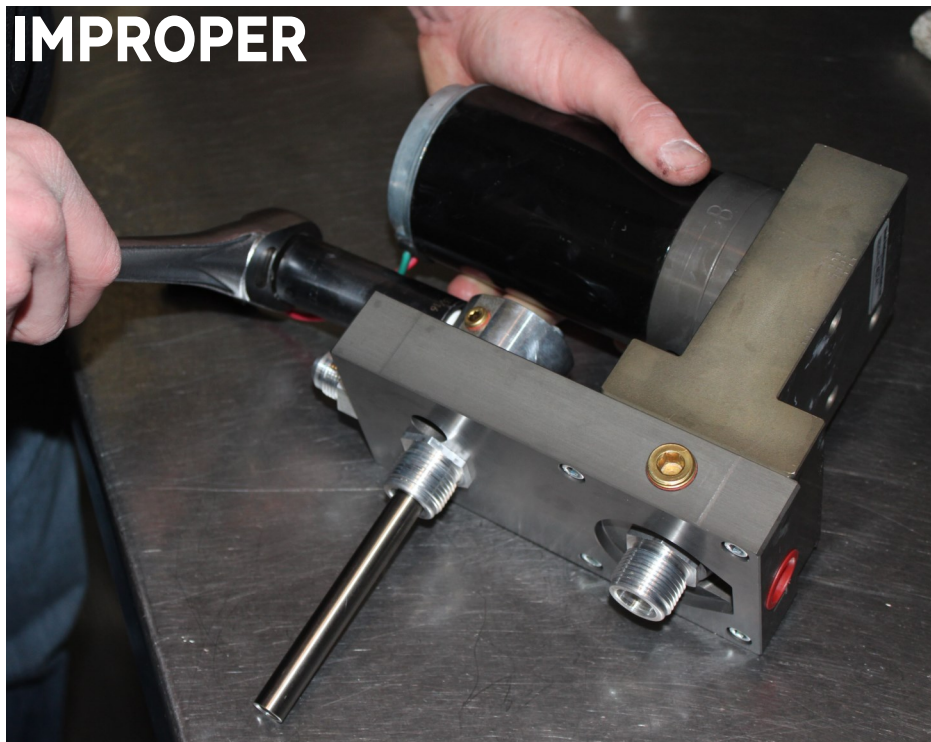
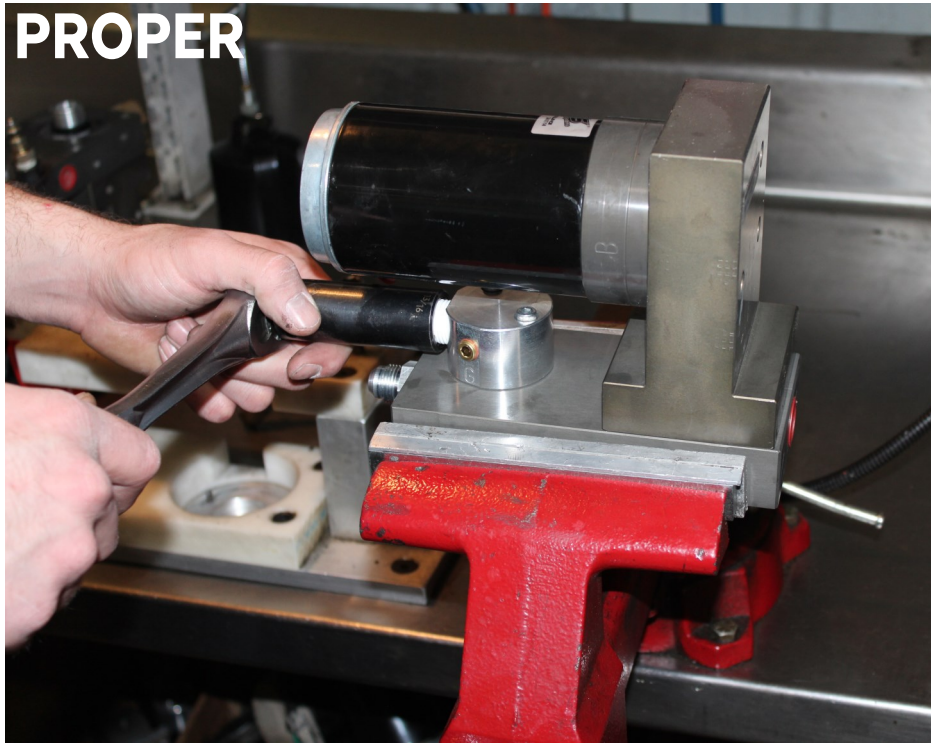

STEP 3: MOUNT FUEL SYSTEM

NOTE: Before installing fittings make sure to inspect for burs or flare imperfections. When cutting fuel line make sure to blow out line to keep debris from moving forward..

- A. Install 10-300 into the "E" port and 10-301 into the "T" port of the FASS, torque to 20 ft./lbs.
FITTINGS COME EQUIPPED WITH THREAD SEALANT, DO NOT USE THREAD TAPE

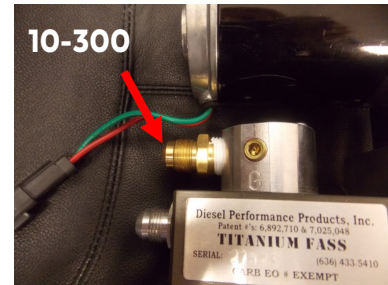
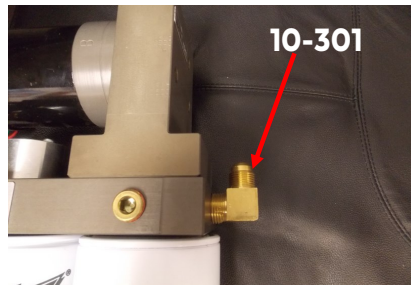

- B. For fitting purposes. Secure PBR-2001 to pump assembly lightly with (3) 1/4"-20x1 3/4 bolts and (3) WA-1001D. Assembly will be used in future steps for correct fitting of brackets. (Note: Bracket may-be flipped to accommodate your application.)

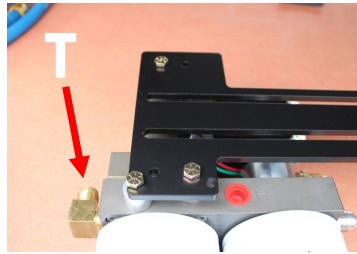
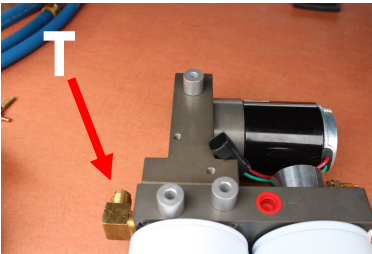

- C. Unbolt driver side.



STEP 3: **MOUNT FUEL SYSTEM**

D. Secure PFB-2002 and RS-2001 with bed bolt in previous step.



E. Position the PBR-2001 to the PFB-2002 pump assembly at the mounting location and check for fit. Once location is established mark location for mounting in next step.

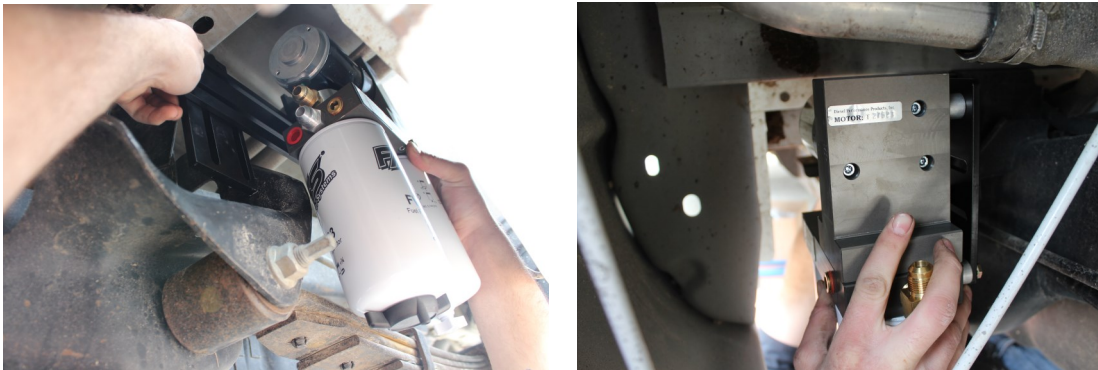

F. Connect female plug of the FASS harness into pump. Turn key to "on". With pump operating (you may have to bump the starter), turn pump over, liberally spray WD-40 (or equivalent) into water separator nipple lubricating Gerotor.



STEP 3:

MOUNT FUEL SYSTEM

G. Assemble the FASS pump bracket PBR-2001 using the RS-2002 spacer between PFB-2002 and PBR-2001 bracket with 4-3/8 bolts, nuts, and washers. **Note: Torque bolts not flange nut.**

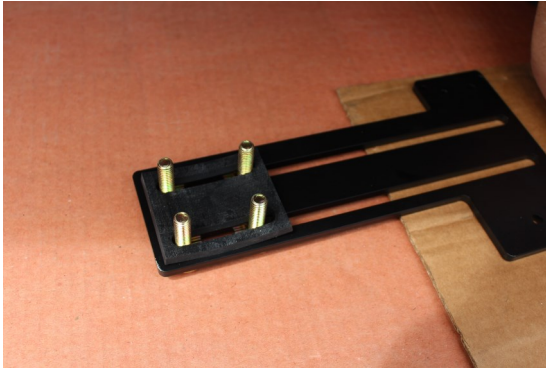

H. Once secure use 3-1 3/4 bolts and 3-WA-1001D spacers to mount the pump to the bracket.

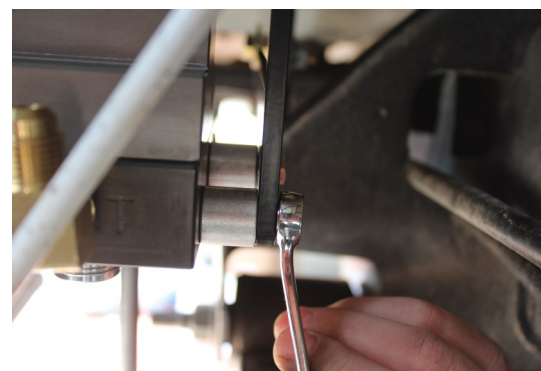
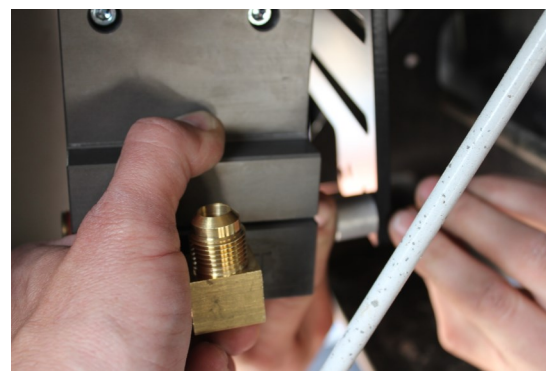

STEP 3: MOUNTING THE FASS

Extreme Water Separator-Install XWS-3002 on side of pump with draw tube in the middle of the filter nipple.



Particulate Filter -Install PF-3001 on water separator nipple without the draw tube. Make sure to insert O-Ring provided on nipple.

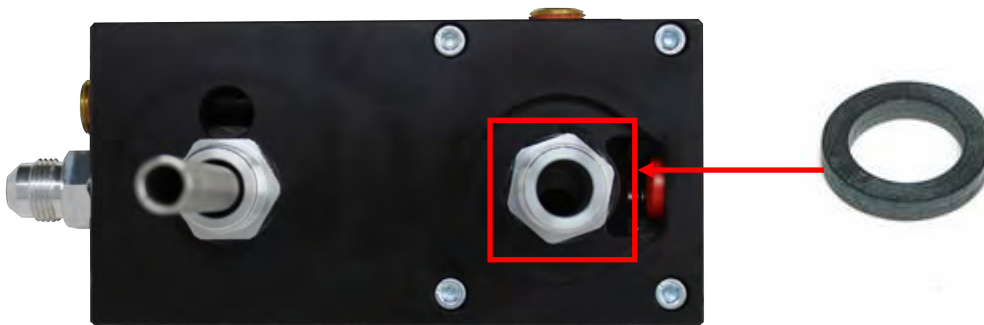

STEP 4: INSTALL FUEL LINE

Caution: DO NOT use sealant on AN fittings

- A.** Route suction line to 'T' port . Cut FL-1002 to length. Insert PL-1005 in line using oil. Attach to 10-301. Torque to 18 ft./lbs.

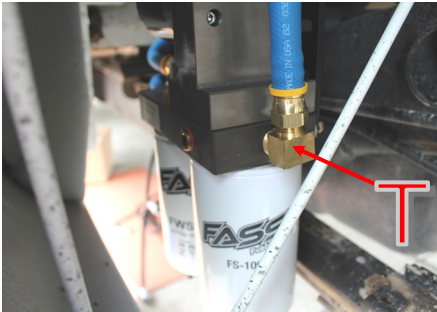

NOTE: Hose clamps are not recommended for push lock fittings and can damage the strength of hose. They will hold up to 300psi! Use oil on fittings and inside fuel line when installing Push-Lok fittings

- B.** Route fuel line from the 'R' fitting to RM-1004 in the filler neck with a gentle bend. Cut and insert the PL-1005 fitting to the hose. Use oil. Attach fitting to the 'R' port. Torque to 18 ft./lbs.



- C.** Insert PL-1005 in remaining fuel line. Connect to the 'E' port of the FASS system. Use oil. Torque to 18 ft./lbs. Route this line up to the injection pump.



STEP 4: **INSTALL FUEL LINE**

2003 - 2004 CP3 (Injection Pump)

D. Disconnect factory fuel line from inlet side of the factory injection pump, Install the DIPF-1003 fuel fitting into this inlet port. (Note: This is where the suction fuel line from the fuel filter enters the injection pump.)



E. Measure and cut fuel line. Insert PL-2003 90° Push-Lok fitting using oil. Install fitting onto DIPF-1003. Torque to 18 ft/lbs.



1998.5 - 2002 VP44 (Injection Pump)

D. Disconnect factory fuel line from inlet side of the factory injection pump, Install the DIPF-1003 fuel fitting into this inlet port. (Note: This is where the suction fuel line from the fuel filter enters the injection pump.)



E. Measure and cut fuel line. Insert PL-2003 90° Push-Lok fitting using oil. Install fitting onto DIPF-1003. Torque to 18 ft/lbs.

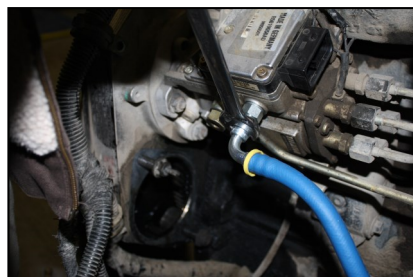

STEP 5: **REVIEW INSTALLATION**

1. Blow out any open lines/cover any open ports
2. Bolts and fasteners properly tightened?
3. Electrical harness and fuel lines secured and properly tightened? Reconnect the battery.
4. Has the system been primed?
 - a. Turn key to the ignition position, turning on the FASS pump for 15 sec..
 - b. Crank engine and allow to run for at least 1 minute.
5. Check for leaks.
6. Start the engine
7. Recheck all fluid and filter connections for leaks
8. This pump comes with a 1 Year Manufacturer's Warranty based on the date it has been manufactured. To receive your extended Lifetime Warranty, you have 30 days from date of purchase to send the completed warranty information

To assist with priming your FASS pump crack the XWS-3002. Put power to the FASS pump to activate the pump. When the tone of the pump changes you can tighten up the fuel filter. If you need a video of the priming process go to www.FASSride.com.



Note: The Red Plastic Plugs located in the "H" ports can stay in place fuel will not flow through these ports. Coolant can be plumbed into these ports to heat the fuel in the Winter months.



NOTE:

POSSIBILITY FOR CODE P0628!

With the removal or disconnection of the factory lift pump, it is possible for code P0628 to occur. This code should not cause a MIL, it will remain stored in the ECM.



www.fassride.com

(866) 769.3747

LIMITATION OF LIFETIME WARRANTY

Disclaimer: To help insure you receive the proper system and customer support at the local level, FASS has a VIP and Authorized Dealer network representing FASS products. This is one reason you must purchase through a dealer to comply with our warranty policies. If you do not, there is no warranty! We recommend you go to www.FASSride.com, click "Find a Dealer", put in their ZIP code, select the type of dealer, and see if the company you purchased from is listed. If they are not, put their phone number in the field below the ZIP code field to see if they are listed. Below these two fields is a list of "Terminated/Unauthorized" dealers. You may want to review this list. If the company is not listed or is on the "Terminated/Unauthorized" list, we suggest you return the product immediately to that dealer and call FASS. We'll recommend you to the nearest dealer.

Diesel Performance Products, Inc. (hereafter "SELLER") gives Limited Warranty as to description, quality, merchantability, fitness for any product's purpose, productiveness, or any other matter of SELLER'S product sold herewith. The SELLER shall be in no way responsible for the product's open use and service and the BUYER hereby waives all rights other than those expressly written herein. This Warranty shall not be extended or varied except by a written instrument signed by SELLER and BUYER.

When MANUFACTURER receives the "ORIGINAL" PRODUCT REGISTRATION form with a copy of the "BILL OF SALE/SALES RECEIPT" within 30 days of the sale, then the following applies! The Warranty will then and only then be validated to that of which typically accompanies your unit for your specific application from the date of sale or for recommended service life and limited solely to the original purchaser and/or vehicle and parts contained within the product's kit. This warranty does not cover normal wear on consumable items such as but not limited to filters, fuel line, wire harness & etc. The warranty does not cover seized gears due to lack of filtration. Warranty is voided if used with other than diesel fuel. Returned items will arrive prepaid to the place of purchase. Diesel Performance Products, Inc. will repair, without cost, any product found to be defective during the warranty period; parts only, or at its option, will replace such products in exchange for the product. Repair or replacements are warranted for the remainder of the original warranty period. All Warranty claims are subject to approval by Diesel Performance Products, Inc.

A Return Material Authorization (RMA) number must be obtained before any product is to be returned to Diesel Performance Products, Inc. for warranty consideration, repair or product return. Requests for product returns must be offset by an equal value order. Return parts must be completed and in resalable condition. No returns after 30 days.

The following information is required to obtain a RMA number before returning product:

Your Name, Address, and Phone Number's

Model and Serial Number (Not Motor Number) Example: Model HD Series, Serial: 00125966 VIN Number of Vehicle

Date of Purchase

Nature of Problem

RMA and Product Serial Number must be on all paperwork and correspondence. Failure to obtain the required information or paperwork will result in \$25.00/item penalty and delay or denial of any warranty claim.

Under no circumstances shall the SELLER and/or MANUFACTURER be liable for any labor charged or travel time incurred in diagnosis for defects, removal, or reinstallation of this product, or any other contingent expenses.

Under no circumstances shall the SELLER and/or MANUFACTURER be liable for any damage or expenses insured by reason of the use or sale of any such equipment. This warranty does not apply to products which Diesel Performance Products, Inc. has determined to have been misused or abused, improperly maintained by the user, or where the malfunction or defect can be attributed to the use of non-genuine Diesel Performance Products, Inc. parts.

IN THE EVENT THAT THE BUYER DOES NOT AGREE WITH THIS AGREEMENT: THE BUYER MAY PROMPTLY RETURN THIS PRODUCT, IN A NEW AND UNUSED CONDITION, WITH A DATED PROOF OF PURCHASE, TO THE PLACE OF PURCHASE WITHIN THIRTY (30) DAYS FROM DATE OF PURCHASE FOR A FULL REFUND LESS SHIPPING.

THE INSTALLATION OF THIS PRODUCT INDICATES THAT THE BUYER HAS READ AND UNDERSTANDS THIS AGREEMENT AND ACCEPTS ITS TERMS AND CONDITIONS.