



Cognito SM Series LDG Traction Bar Kit for 2020 GM 2500HD/3500HD 2WD/4WD Trucks

**INSTALL INSTRUCTIONS:**

Cognito SM Series LDG Traction Bar Kit for 2020 GM  
2500HD/3500HD 2WD/4WD Trucks  
SKU: 110-90952

**PARTS LIST FOR SKU: 110-90952**

QUANTITY	PART #	DESCRIPTION
4	8460	Traction Bar Shackle
2	<b>8521</b>	45" SM Traction Bar
2	8721	Leaf Spring Axle Bracket
1	8775	6-9" Frame Mount Driver
1	8776	6-9" Frame Mount Passenger
1	70135	Misc. Parts Box



**PARTS LIST FOR SKU: 8521 (PRE-INSTALLED)**

QUANTITY	PART #	DESCRIPTION
1	6208	GIRO Bushing
1	6227	1.25"-12 Forged Rod End
1	6229	Traction Bar Adjuster Nut
2	HARDWARE-93307	3/8"-16 x 1.25" Socket Head Cap Screw
2	HARDWARE-3/8-LW-SHCS	3/8" Split Lock Washer

**PARTS LIST FOR SKU: 70135**

QUANTITY	PART #	DESCRIPTION
1	8724	Nut Plate Driver
1	8725	Nut Plate Passenger
1	HP9205	Traction Bar Kit Hardware
1	HP9214	Traction Bar Bushing Kit

**WARNING**

Please read this entire instruction sheet before beginning installation. Proper installation of these components requires a qualified mechanic. Always wear safety glasses when using power tools, and take appropriate precautions when working under a vehicle. If these instructions are not properly followed you may jeopardize your, and your passenger's safety, and severe frame, suspension or tire damage may also result from improper installation.

**PARTS LIST FOR SKU: HP9205**

QUANTITY	PART #	DESCRIPTION
2	POLY-BUMPSTOP-6079G	Black Polyurethane Bump Stop
4	HARDWARE-15207	1/2"-13 x 1.25" Bolt
4	HARDWARE-15212	1/2"-13 x 2.25" Bolt
2	HARDWARE-15269	9/16"-12 x 4" Bolt
2	HARDWARE-15273	9/16"-12 x 5" Bolt
2	HARDWARE-33082	3/8" Flat Washer
12	HARDWARE-33086	1/2" Flat Washer
8	HARDWARE-33088	9/16" Flat Washer
4	HARDWARE-33626	1/2" Lock Washer
2	HARDWARE-37264	3/8"-16 Lock Nut
4	HARDWARE-37268	1/2"-13 Lock Nut
4	HARDWARE-37270	9/16"-12 Lock Nut
2	HARDWARE-93305	3/8"-16 x 1.00 Socket Head Cap Screw

**PARTS LIST FOR SKU: HP9214**

QUANTITY	PART #	DESCRIPTION
4	5036	Crush Sleeve
2	5045	Crush Sleeve
8	6715	Black Polyurethane Shackle Bushing
4	POLY-BUSHING-2509.1	Black Polyurethane Spring Bushing



## INTRODUCTION

Traditionally traction bars have a fixed length and fixed front pivot point. The nature of a leaf spring is to bend to do its job of carrying vertical load. When the spring is bending, the distance between the fixed front pivot bolt of the spring and the axle housing changes through the suspension cycle because the leaf spring is bending to do its job. A fixed length traction bar coupled with a leaf spring that is changing length causes binding as the axle travels in the suspension cycle. The Cognito Limited Dynamic Geometry traction bar kit allows the length of the traction bar and shackle assembly to vary with the leaf spring through the suspension cycle under normal operating conditions, without binding via the use of the shackle. The length of the traction bar assembly at its longest position, which is when the shackle is lined up with the traction bar, is used to control axle wrap and wheel hop that can happen when high torque loads are applied by heavy acceleration and/or heavy weight loads.

## REQUIREMENTS

- Installation requires a qualified mechanic.
- Always wear safety glasses when using power tools.
- Proper vehicle lifting equipment is required.
- Read instructions carefully and study the pictures before attempting installation.
- Due to variations between stock and lifted vehicles, U-bolts are not included with this kit. This kit requires 1/2" additional U-bolt length for the axle bracket. Contact Cognito if your application requires longer U-bolts.

## TECH NOTES

- Check the parts and hardware packages against the parts list to assure that your kit is complete.
- Work through these instructions on both sides of vehicle at the same time to completion. The order of the steps is important.
- Torque bolts to the specifications listed at the end of these instructions.
- This kit is for 6-to-9-inch lifted applications in the rear.

## TOOLS YOU WILL NEED

- Impact Driver
- Drill
- Ratchet
- Ratchet Socket Extensions
- Torque Wrench (ft-lbs.)
- Hammer
- Floor Jack
- Center Punch
  - 1/2-inch
- Allen Hex Key
  - 8-mm
- Sockets/Wrenches:
  - 24-mm
  - 27-mm
  - 9/16-inch
  - 3/4-inch
  - 13/16-inch
  - 7/8-inch
- Drill Bit
  - 1/2-inch

1. Support the vehicle's frame on a lift or on jack-stands so that the rear wheels are off the ground. NEVER WORK ON AN UNSUPPORTED VEHICLE.
2. Use a floor jack to lift the rear differential housing a few inches to relieve tension on the forward leaf spring mounting bolt, see Figure 1. Ensure the vehicle's frame does not lose contact with the lift or jack-stands that are supporting the vehicle's weight and do not put tension on any cables or lines.

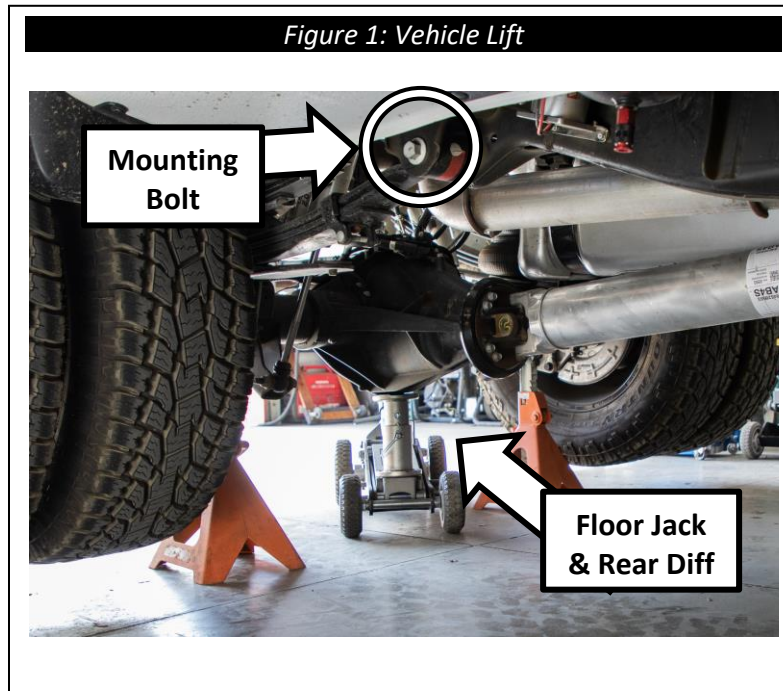

3. Remove the forward leaf spring mounting bolt using an impact with a 24-mm socket. Place the hardware safely aside, it will be reused later.
4. Locate the driver side **8775** Cognito Frame Mount Bracket and align it against the frame, see Figure 2. Reinstall the forward leaf spring mounting bolt, but do not fully tighten.
5. Press the frame mount bracket against and tighten the forward leaf spring mounting bolt enough that the frame mount bracket will not easily move, see Figure 2.

*Figure 2: Frame Mount Bracket Installation*

6. Use a center punch to mark the location of the mounting holes onto the vehicles frame, see Figure 3.

*Figure 3: Frame Mounting Hole Marking*

7. Either loosen the forward leaf spring mounting bolt and swing the frame mount bracket away from the frame or use the frame mount bracket as a drill template, and drill through the bottom side of the frame using a 1/2" drill bit, see Figure 4.

Figure 4: Drilling Bottom Side of Frame



8. Locate the driver side **8724** Cognito Nut Plate and insert the plate through the hole in the frame above the frame mount bracket.

Figure 5: Cognito Nut Plate Installation

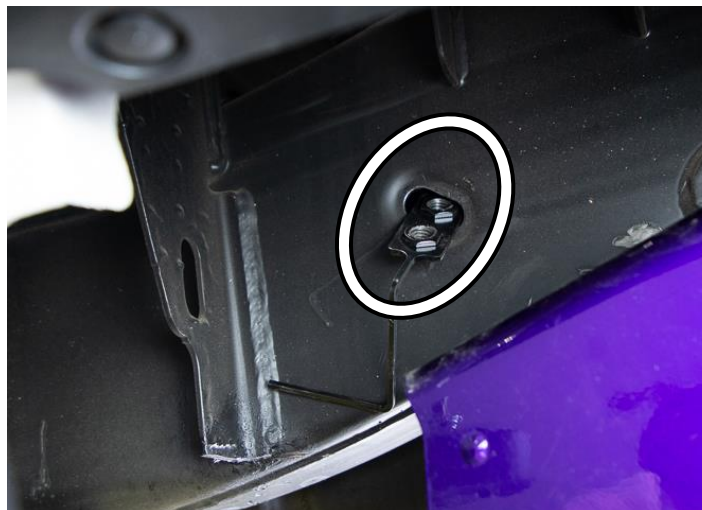

9. Locate **HP9205** and find the two (2) 1/2" flat washers, two (2) 1/2" lock washers, and two (2) 1/2"-13 x 1.25" bolts. Install the lock washer between the flat washer and the bolt head and bolt the frame mount bracket to the nut plate, see Figure 6. Tighten and torque these two (2) bolts to 90 ft-lbs.



*Figure 6: Frame Mount Bracket and Nut Plate Installation*

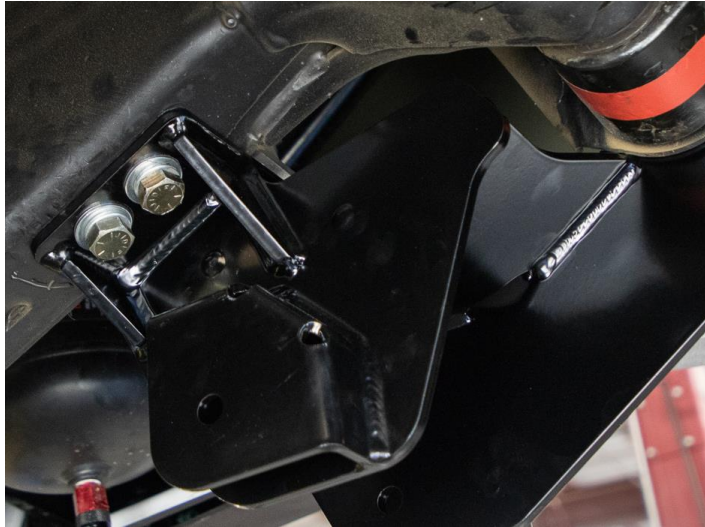

10. Locate two (2) **8460** Cognito Traction Bar Shackles and **HP9214**. Find four (4) **6715** shackle bushings and two (2) **5036** crush sleeves from within the hardware pack. Install two (2) bushings and one (1) crush sleeve per shackle, see Figures 7 and 8.

**Note:**

**Do not** add grease or lubricant to the outside of the bushings prior to pressing them into the shackles. If needed, apply grease or a light lubricant to the inside bore of each bushing to ease the installation of the crush sleeves.

*Figure 7: Shackles and Hardware*



*Figure 8: Shackles and Hardware Installation*



11. Locate **HP9205** and install the assembled shackles to the frame mount bracket using two (2) 1/2"-13 x 2.25" bolts, two (2) 1/2" flat washers, and 1/2"-13 lock nuts, see Figure 9.



12. Locate **HP9205** and find one (1) bump stop, one (1) 3/8"-16 x1.00 socket head cap screw, one (1) 3/8" flat washer, and one (1) 3/8"-16 lock nut. Install the bump stop using the hardware, an 8-mm Allen key, and a 9/16" wrench to the bottom of the frame mount bracket, see Figure 10. The bump stop only needs to be tightened so that it is firmly held in place, do not over-tighten.

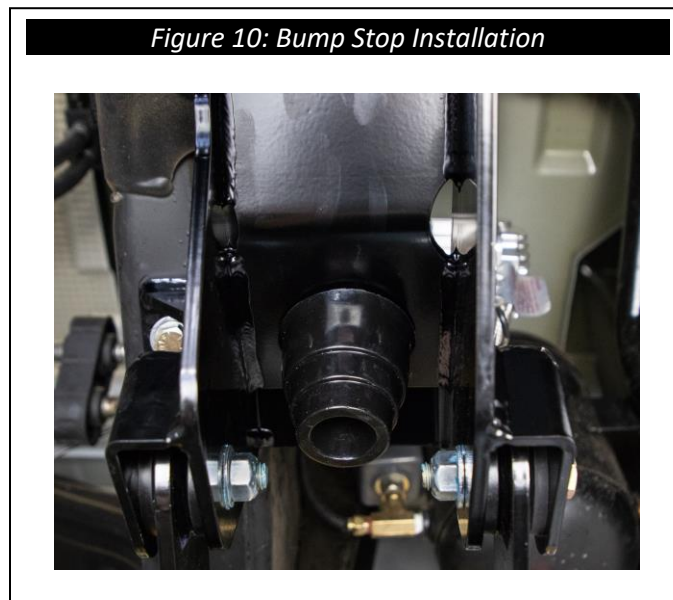



13. Repeat the steps above on the opposite side of the vehicle.
14. **For the following steps**, the vehicle will need to be lowered and placed on the ground at a normal operating position.
15. Remove the four (4) U-bolt nuts from one side of the vehicle using an impact and a 27-mm socket, see Figure 11.
16. Locate the **8721** Cognito Leaf Spring Axle Bracket and slide it over the U-bolts with the mounting eyelets offset towards the front of the vehicle, see Figure 12.

**Note:**

Due to variations between stock and lifted vehicles, U-bolts are not included with this kit. This kit requires 1/2" additional U-bolt length for the axle bracket. Contact Cognito if your application requires longer U-bolts.

**Note:**

The flat edge of the axle bracket should be facing towards the front of the vehicle.

Figure 11: U-Bolt Removal



Figure 12: Leaf Spring Axle Bracket Installation

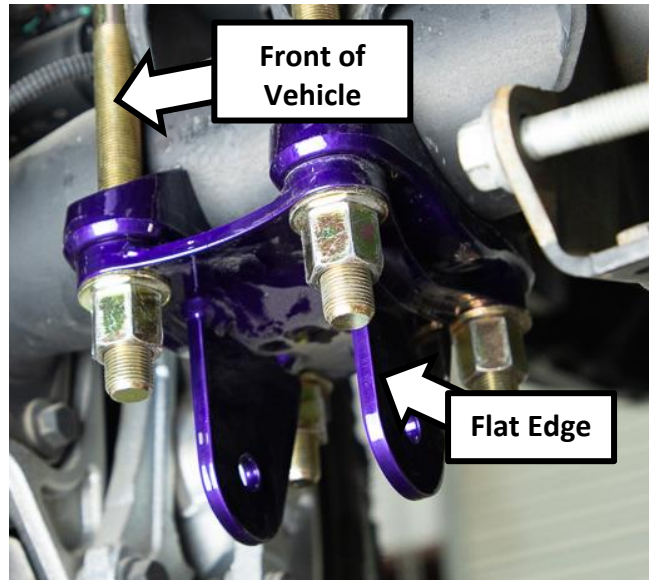

17. Locate the **8521** Cognito SM Traction Bars and **HP9214**. Find the four (4) poly bushings, and the two (2) **5045** crush sleeves, see Figure 13.
18. Install two (2) bushings and one (1) crush sleeve per traction bar.

**Note:**

**Do not** add grease or lubricant to the outside of the bushings prior to pressing them into the traction bars. If needed, apply grease or a light lubricant to the inside bore of each bushing to ease the installation of the crush sleeves, see Figure 14.

*Figure 13: Traction Bar and Hardware**Figure 14: Traction Bar Bushing Grease Application*

19. The **8521** traction bars will be pre-equipped with a rod end, adjuster sleeve, and hardware. Ensure that the rod end and the adjuster sleeve are threaded all the way into the traction bar.

*Figure 15: Traction Bar Rod End*

20. Locate **HP9205** and find one (1) 9/16"-12 x 5" bolt, two (2) 9/16" flat washers, and two (2) 9/16"-12 lock nuts. Install the traction bar end with the bushings between the frame mount bracket shackles, see Figure 15.



21. Locate **HP9205** and find one (1) 9/16"-12 x 4" bolt, two (2) 9/16" flat washers, and two (2) 9/16"-12 lock nuts. Install the traction bar rod end between the eyelets on the rear axle mount, see Figure 16.

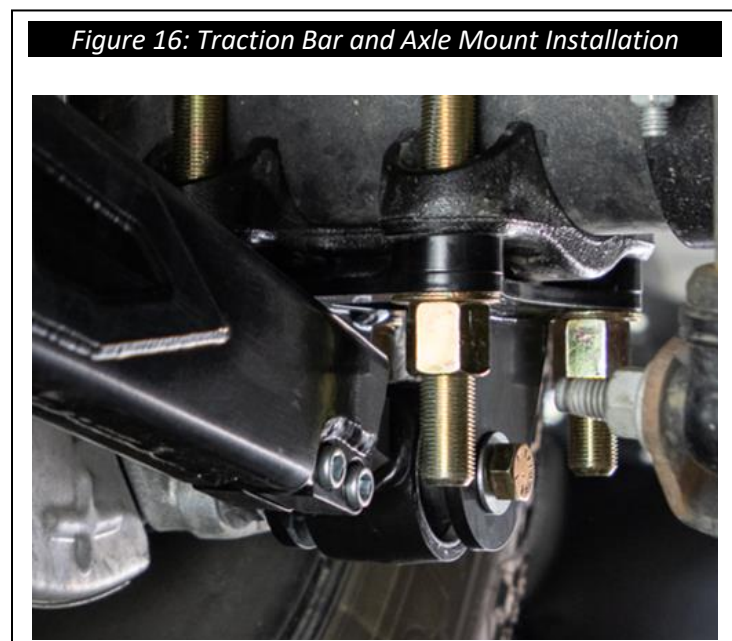



22. Repeat the steps above on the opposite side of the vehicle.
23. Once the traction bars have been installed, allow the vehicle to rest at ride height.
24. Adjust the length of the traction bar by turning the adjustment sleeve, see Figure 17. Lengthen the bar until the adjuster feels tight and hard to freely turn (this happens when the traction bar is at it's maximum length).

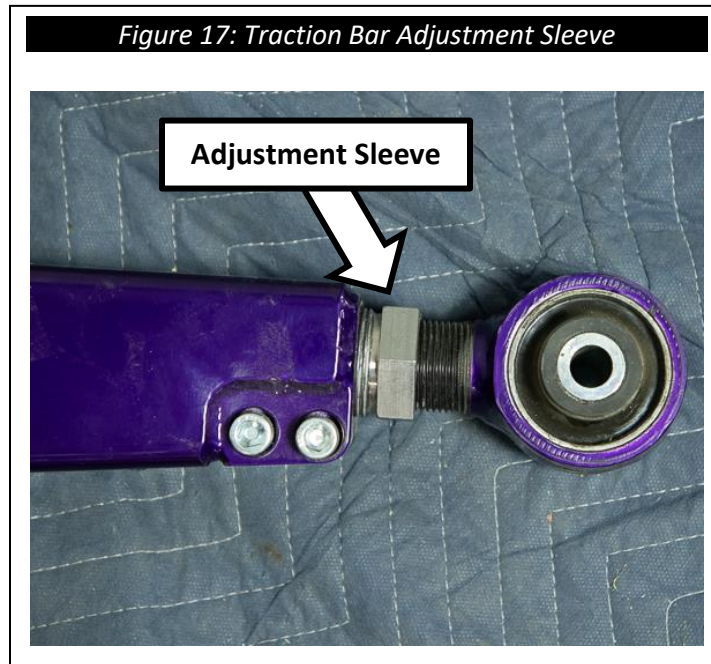

25. With the adjuster tight and hard to freely turn, shorten (turn in the opposite direction) the adjuster by 1/4 of a revolution. Tighten the 3/8" socket head cap screws and torque to 40 ft-lbs. using an 8-mm Allen key to lock the adjuster in place, see Figure 18.

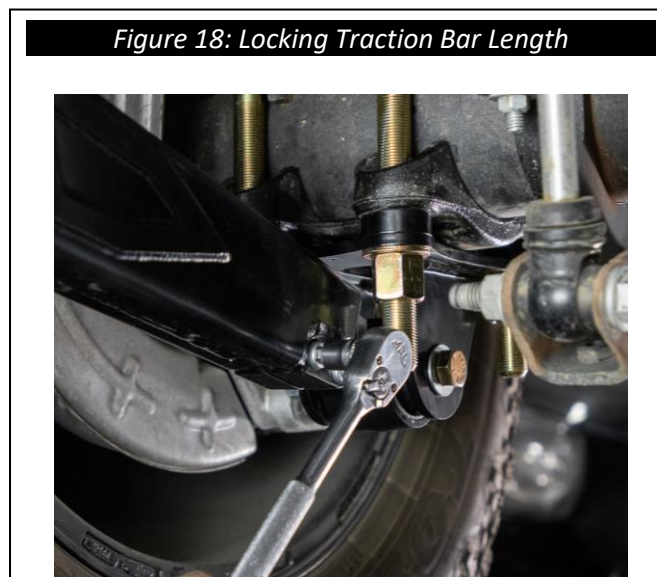

26. Do not exceed **2.00"** of thread showing from the face of the traction bar to the start of the threads on the eyelet, see Figure 19.

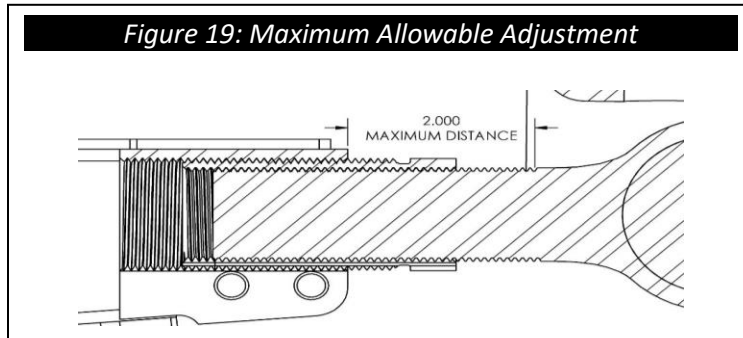

27. The traction bar should now form a very small angle with the shackles and be close to or slightly touching the bump stop on the frame mount bracket, see Figure 20.



28. Repeat these steps for the opposite side of the vehicle.

29. Torque hardware (except for bump stop hardware) to the following specifications,

Hardware	Torque Spec (ft-lbs.)
3/8"-16 UNC SHCS	40
1/2-13 UNC	90
9/16-12 UNC	120
3/4" U-Bolt nuts	170





## WARRANTY / RETURN POLICY / SAFETY

### Cognito Limited Lifetime Warranty

Cognito Motorsports, Inc. hereinafter “Cognito,” warrants to the original retail purchaser, that its suspension products are free from workmanship and material defects for as long as the purchaser owns the vehicle on which the product(s) were originally installed. This warranty will be void if any modifications are made to the components, including alterations to the surface finish, i.e., painting, powder coating, plating, and/or welding, or if they are improperly installed. Cognito truck suspension products are not designed nor intended to be installed on “competition” vehicles used in race applications, stunt or for exhibition purposes that are outside of the intended operating conditions specified by the manufacturer. Racing and competition are defined as any contests between two or more vehicles; or vehicles competing individually on off road circuits in timed events (whether or not such contests are for an award or prize).

This warranty does not include coverage for police, taxi, government or commercial vehicles, and the warranty does not cover Cognito products sold outside of the USA. Cognito’s obligations under this warranty are specified and applied at its sole discretion, and warranty coverage is limited to repair or replacement of the defective product(s). Any and all costs of removal, installation, or reinstallation; freight charges, incidental or consequential damages associated with the covered products are expressly excluded from this warranty.

The following items are exempt from Cognito limited warranty coverage: bushings, bump stops, tie-rod ends (Heim joints) and limiting straps. These parts are “consumables” and designed to wear as a normal part of their duty cycle, therefore they are not considered defective when worn. The aforementioned products are warrantied separately against defects in workmanship, for 60 days from the date of purchase. As a condition of warranty validation, respective Cognito suspension components must be installed as a complete system (not combined with non-Cognito hardware or ancillary parts). Any substitutions or omission of required components will void the warranty. Some minor cosmetic wear and imperfections may occur to parts during shipping, which is not covered under this warranty. This limited warranty does not apply to any components that have been subjected to collision damage, negligence, alteration, abuse, or misuse, and coverage does not extend to products manufactured by third-party companies. Cognito reserves the right to supersede, discontinue, or change the design, finish, part number and/or application of its parts when deemed necessary, without notice.

### Return Policy

Product returns will not be accepted without prior written approval from an authorized Cognito representative. All products being returned must be shipped via trackable, prepaid freight. Returned products are subject to a 25% percent restocking fee. The eligible return period for products purchased directly from Cognito is 30 days from the verified date when the product(s) were originally received by the purchaser.

### Product Safety Advisory

The installation of Cognito steering and suspension components will modify your vehicle’s original factory equipment and geometry, which may cause it to handle differently than a stock (unaltered) vehicle. Installation of these components is not intended to strengthen nor reinforce the vehicle’s frame, nor are they designed to increase rollover protection. It is necessary to periodically inspect all suspension and drive train components for proper attachment, torque specifications, operation, and for any potential unusual wear or damage. Installation of these parts will modify the height of the vehicle and may raise the center of gravity. Modifying vehicle height combined with off road operation may increase your vehicle’s susceptibility to rollover conditions, which may cause serious injury or death. Many states regulate allowable vehicle height modifications, and it is your responsibility to know and comply with the legal requirements specified by the laws where you reside. Modifications to your vehicle’s ride height may also affect the ride quality, driver input response, trackability and handling, and wear to your vehicle’s suspension components and tires.