



34935 Flyover Ct. Bakersfield, CA 93308
Phone: (661) 588-8085 | Fax: (661) 588-8295

INSTALL INSTRUCTIONS:

Cognito 3-Inch Standard
Leveling Kit for 2019-2021
Silverado/Sierra 1500
2WD/4WD
SKU: 110-90766



PARTS LIST FOR SKU: 110-90766

QTY.	PART #	DESCRIPTION
1	110-90864	2019-2021 GMC 1500 Upper Control Arm Kit
2	90764	2019-2021 GMC 1500 Strut Spacer
2	6734	2019-2021 GMC 1500 Strut Preload Spacer
1	HP9270	Strut Spacer Hardware Pack
1	INST7238	Fender Well Trimming Instruction Sheet

PARTS LIST FOR SKU: 110-90864

QTY.	PART #	DESCRIPTION
1	8693	2019-2021 GM 1500 Tubular Bolt-In UCA, Driver
1	8694	2019-2021 GM 1500 Tubular Bolt-In UCA, Passenger
2	90722	Bolt-In Ball Joint
1	HP9262	UCA Bushing Hardware Pack
1	HP9274	UCA Bolt-In Ball Joint Hardware Pack

WARNING

Please read this entire instruction sheet before beginning installation. Proper installation of these components requires a qualified mechanic. Always wear safety glasses when using power tools, and take appropriate precautions when working under a vehicle. If these instructions are not properly followed you may jeopardize your, and your passenger's safety, and severe frame, suspension or tire damage may also result from improper installation.

PARTS LIST FOR SKU: HP9270

QTY.	PART #	DESCRIPTION
6	HARDWARE-M10X1.5-FNUT	M10 X 1.5 Zinc Plated Serrated Hex Flange Lock Nut
1	HARDWARE-0708765	1/2" Wire/Tube P Clamp W/Vinyl Cushion
2	HARDWARE-63124	1/2" Wire/Tube P Clamp W/Vinyl Cushion

PARTS LIST FOR SKU: HP9262

QTY.	PART #	DESCRIPTION
4	5024	Crush Sleeve 1.0 X .219 X 2.130 Dom
8	POLY-BUSHING-2757	Black Polyurethane Spring Bushing
4	6468	UCA Bushing Thrust Washer
4	UCA Bushing Thrust Washer	58792 1/4-28" Self-Tapping 90D Angle-Zerk Grease Fitting Utility

PARTS LIST FOR SKU: HP9274

QTY.	PART #	DESCRIPTION
16	HARDWARE-33080	5/16" Flat Washer
8	HARDWARE-37262	5/16"-18 Lock Nut
8	HARDWARE-15057	5/16"-18 x 1-1/4" Bolt

REQUIREMENTS

- Installation requires a qualified mechanic.
- Check the parts and hardware packages against the parts list to assure that your kit is complete.
- **This kit is not for the AT4 and Trail Boss models.**
- **This kit is not compatible with models equipped with Adaptive Ride Control.**
- This leveling kit may only be installed on a truck that has not already been leveled. You cannot stack leveling kits or shock spacers.
- Always wear safety glasses when using power tools. Some cutting is required.
- Compatible with most OEM Wheels and Tires.
- Read instructions carefully and study the pictures before attempting installation.

TECHNICAL INFORMATION

- Cutting and sanding the studs on the factory struts is required.
- Compressing the strut spring is required.
- Depending on your wheel and tire combination, trimming of inner fender and valance will be required.

INSTALLATION

1. If your truck has an ARC link as shown in figure 1, this kit will not fit.
2. Start by racking the vehicle and hoisting it off the ground so that the front wheels are off the ground and the suspension is at full droop. If no hoist is available then jack the front of the truck off the ground and support properly with jack stands. NEVER WORK ON AN UNSUPPORTED VEHICLE.
3. Remove the factory upper control arms. Loosen the ball joint nut of the upper control arm until you can spin the nut with your fingers, but do not fully remove it. Use a pickle fork to separate the ball joint from the spindle, or tap on the side of the spindle next to the ball joint stud with a hammer (see figure 1). When the tapered seat of the ball joint breaks loose, you may then remove the ball joint nut, and separate the factory upper control arms from the spindles.

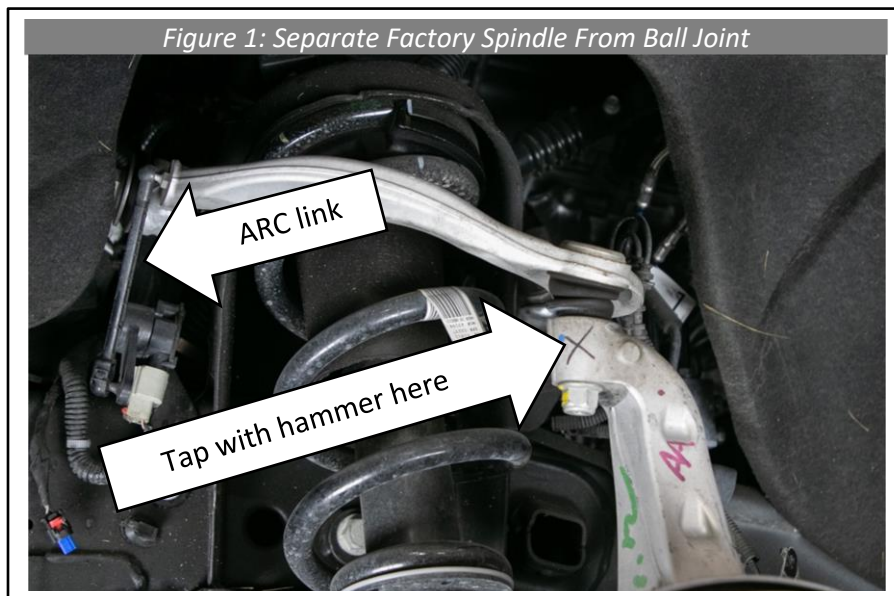

4. Use a 21mm wrench to remove the factory bolts that connect the control arm to the frame but retain them for future use. Place them aside in order so they can be re-installed in the same place they came off.

5. Note that at this time the lower strut screws are holding the lower control arm and spindle in place. Make sure there is a jack stand or other suitable support under the lower ball joint and remove the lower strut screws using a 15mm wrench (see figure 2).

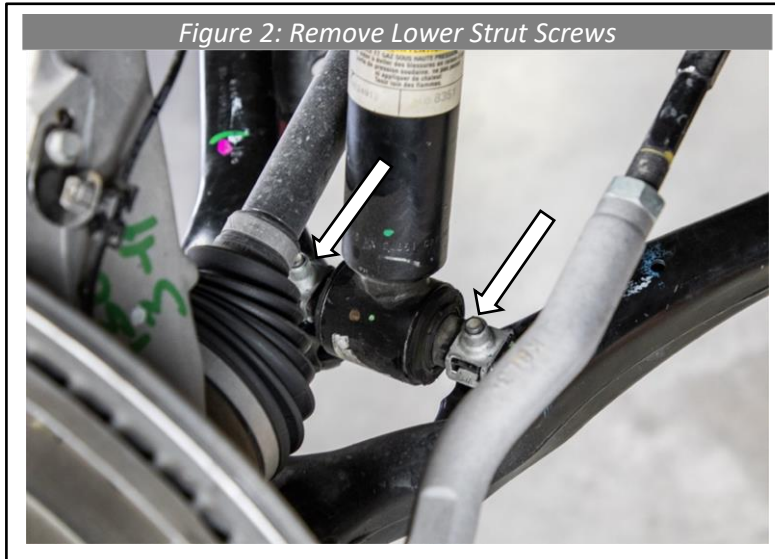

6. Next remove the upper strut bolts. There are 3 of them and they require an 18 mm wrench. The plastic wire chase on the passenger side can be pushed upward enough to get the front 2 off easily (see figure 3). The 3rd in the back is somewhat difficult to remove from the wheel well but can be removed from the engine bay if necessary.

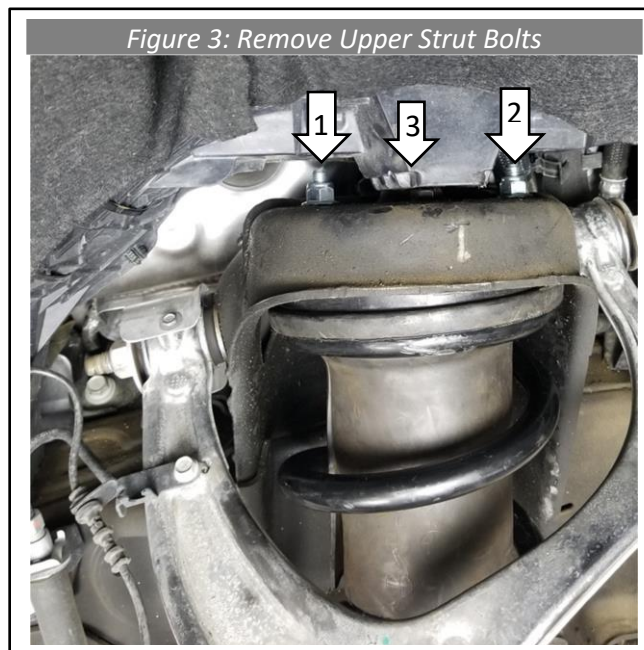

- Using a shock or shock spacers that are too long will cause the upper ball joint to bind and break. Therefore, the OEM shock (or correct length shock) must be used along with this leveling kit. **The included preload ring must only be used with the OEM shock tube and not aftermarket shocks.** Measure from the top surface of the strut hat to the “dimple” feature on the lower pivot axis bar pin (see figure 4). This measurement should be 22.00” plus or minus 1/8”. If anything is used longer than the guidelines specified, warranty will be void and you could damage your upper arms and ball joints and more, which could cause an accident and even death.

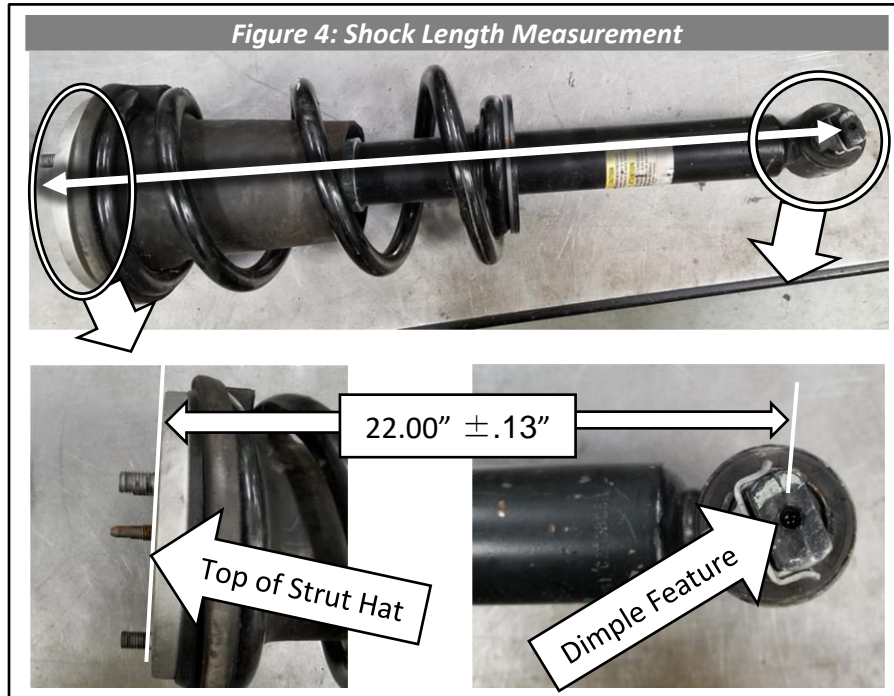

- From the hardware package, insert the polyurethane bushings, crush sleeves, and grease fittings into the ends of the upper control arms. Cognito recommends using black weather-stripping adhesive to ensure secure installation of bushings and use grease to aid installation of sleeves. Do not over tighten the grease fittings, tighten until they are snug and pointing outward toward the tire (See figure 5).

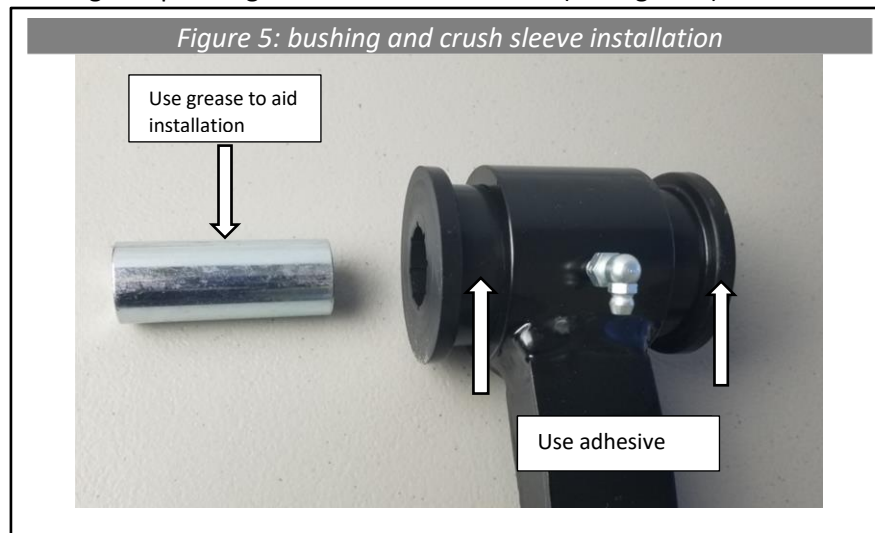

9. Bolt the ball joint to the bottom of the control arm as shown in figure 6 using the included 5/16" hardware. You can determine which side is the bottom and which is top by the logo. Tighten to 18 Ft.-lbs.



10. The Cognito control arms have added caster built in and are side specific. Make sure to mount 8693 to the driver side and 8694 to the passenger side. The badge will be towards the front of the truck and the part numbers are stamped on each arm just behind the ball joint. Mount the arms to the frame with the factory nuts and bolts using the thrust washers on the exposed side of each bushing. Place the arm in the near ride height position and torque to 90 ft-lbs (See figure 7).

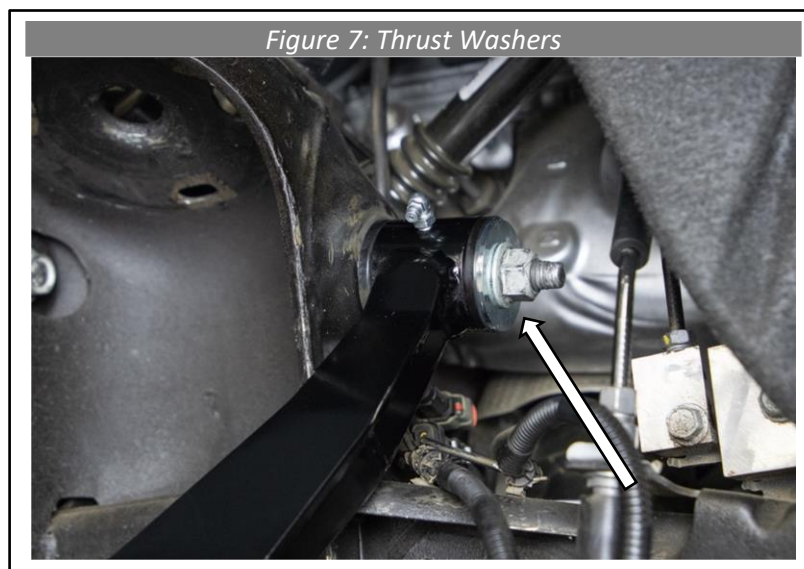

11. Place the strut in a spring compressor, locate the lobe feature on the strut hat, and mark the shock tube directly below the lobe as shown in figure 8 for alignment purposes. Add some pressure to the strut assembly and loosen the center nut using an 18mm socket and impact gun. Note that leaving some tension from the spring on the hat will help prevent the piston rod from spinning while using the impact. The nut can also be removed by using an 18mm and 6mm wrench in combination to prevent the piston rod from turning.

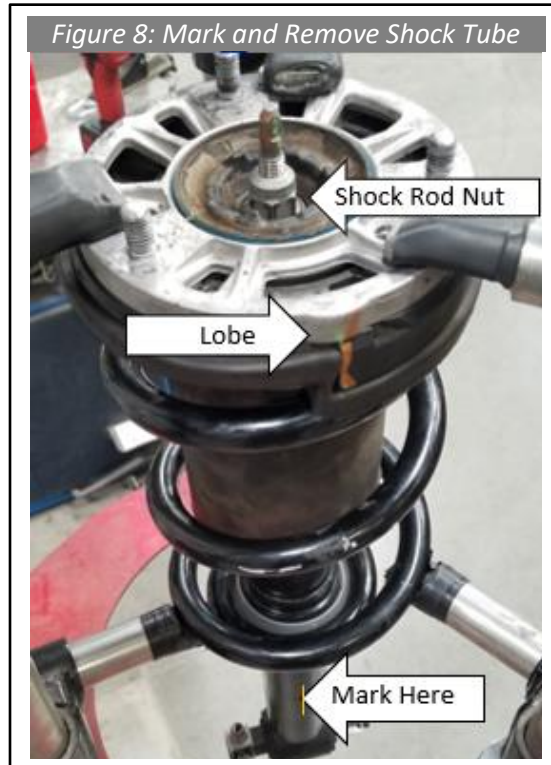

12. Remove the foam bump stop cushion and nylon cover for the spring seat shown in figure 9, setting them aside until reassembly.
13. Install the supplied preload ring making sure the **bottom** of the spacer with the heavy chamfer is facing down against the spring seat. See Figure 10.

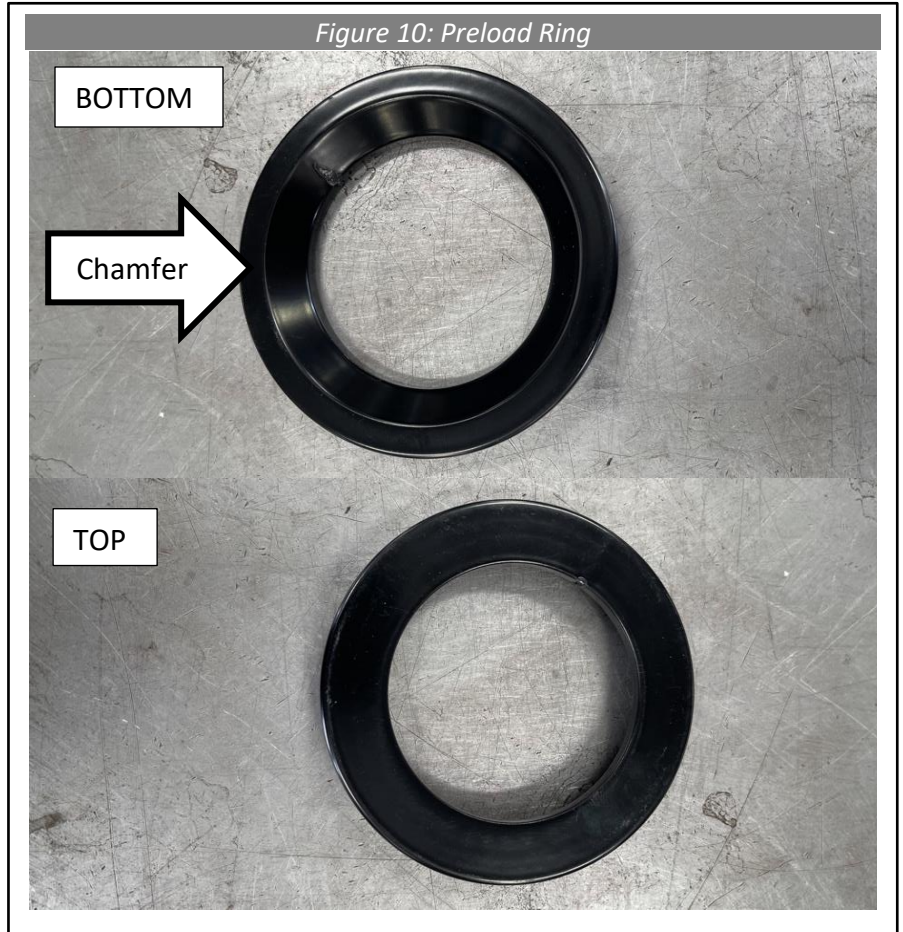

14. Install the preload spacer and nylon cover removed during disassembly. See figure 11.

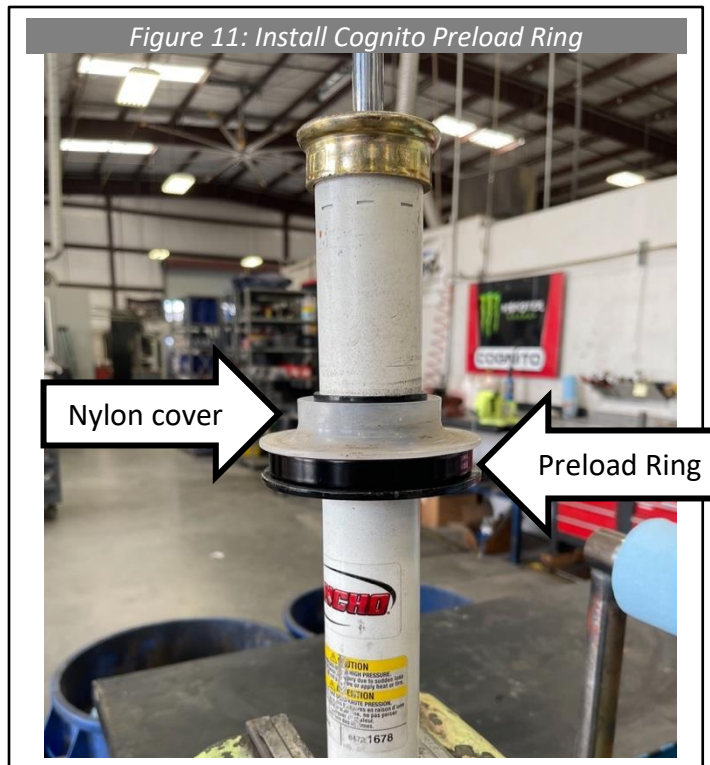

15. When reinstalling the shock to the spring and strut hat, make sure the alignment mark made on the shock tube from step 11 is rotated 180° from its original position. The mark should now be opposite to the lobe feature (see figure 12). Reinstall the sock rod nut in the reverse of its removal.

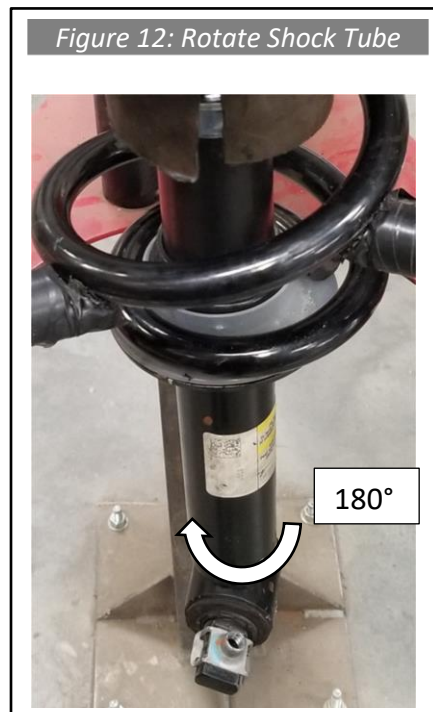

16. Install the supplied m10x1.5 lock nuts all the way down the studs but do not tighten. Mark each stud 1-1.25 inches from the top of the strut hat. Cut the studs off on this mark, if they are left a little long to make sure you don't cut them too short, you can touch up the length with the sanding disk in the next step, just at least get the bulk of the excess stud cut off now. You can use a sanding wheel to add a small chamfer and remove burrs from the cut area as shown in figure 13. Now the nuts can be removed.

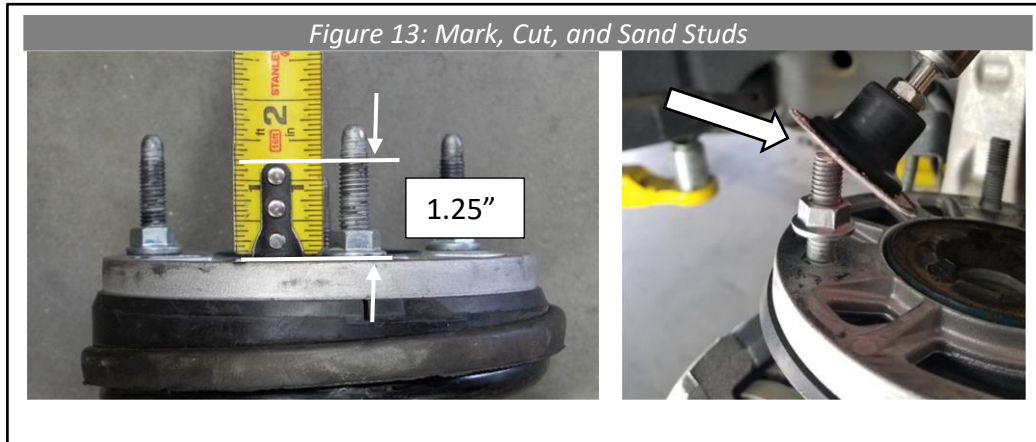

17. Check the stud length by sliding the spacer on and using a straight edge, confirm that the stud does not protrude from the top plane of the spacer (see figure 14). If any do, they must be sanded down until they are flush or below the top of spacer plane. Install the provided m10x1.5 locking flange nuts and torque to 40 ft-lb. There should be visible thread(s) showing past the nut.

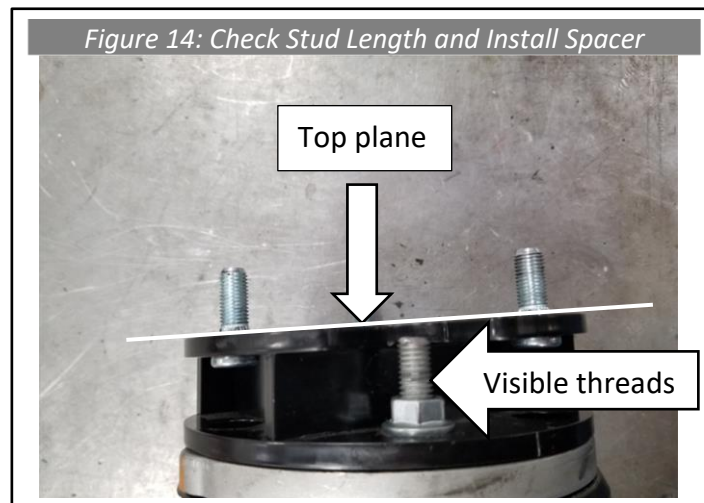

18. Install the strut assembly back on the truck using the m10x1.25 nylon lock nuts provided and torque to 45 ft-lb (see figure 15). Use a pin to help line up the lower strut screws as seen in figure 16 and torque to 40 ft-lb. You will notice that it may be necessary to push on or gently pry the strut in order to get it to fit in its original mounting location, but this is of no concern. The Cognito spacers have the necessary taper built in so the shock is straight at the ride height position.

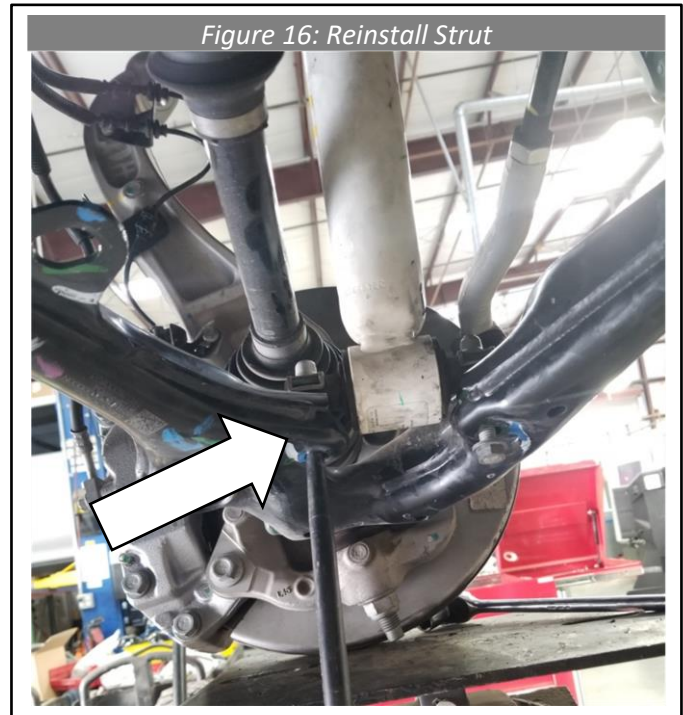
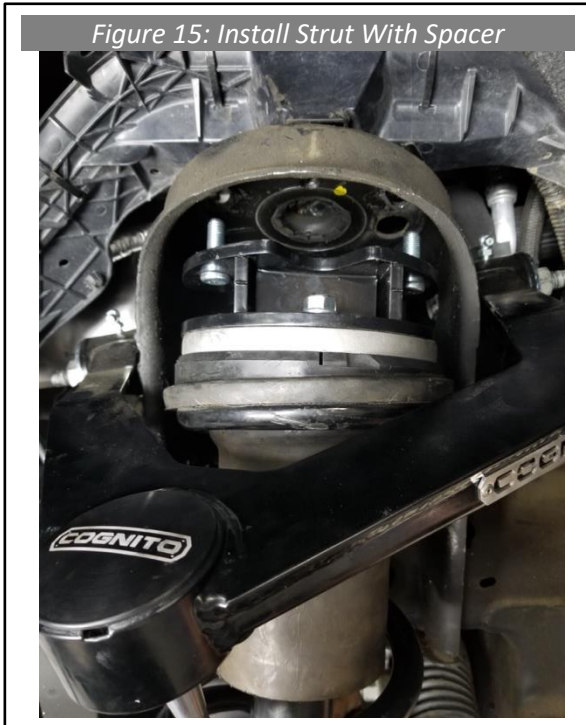

19. Use a very small amount of ANTI-SEIZE and attach the Cognito upper control arm to the spindle using the M12 castle nut and cotter pin provided. Torque the M12 nut on the bottom to 60 ft/lbs using a 19MM wrench or socket. Install the cotter pin.
20. With the extra droop length you now have with this kit, a cable retaining bracket will contact the shock on the drivers side while steering the vehicle under normal operating conditions. Therefore, it is necessary to replace the wheel speed and brake pad wear sensor wire bracket on the driver's side with a provided P-clamp. Remove the 10mm screw from the back side of the spindle. Use the same mounting position and screw to mount the P-clamp. Use the provided wire ties to neatly retain the wires to the brake line (see figure 17).

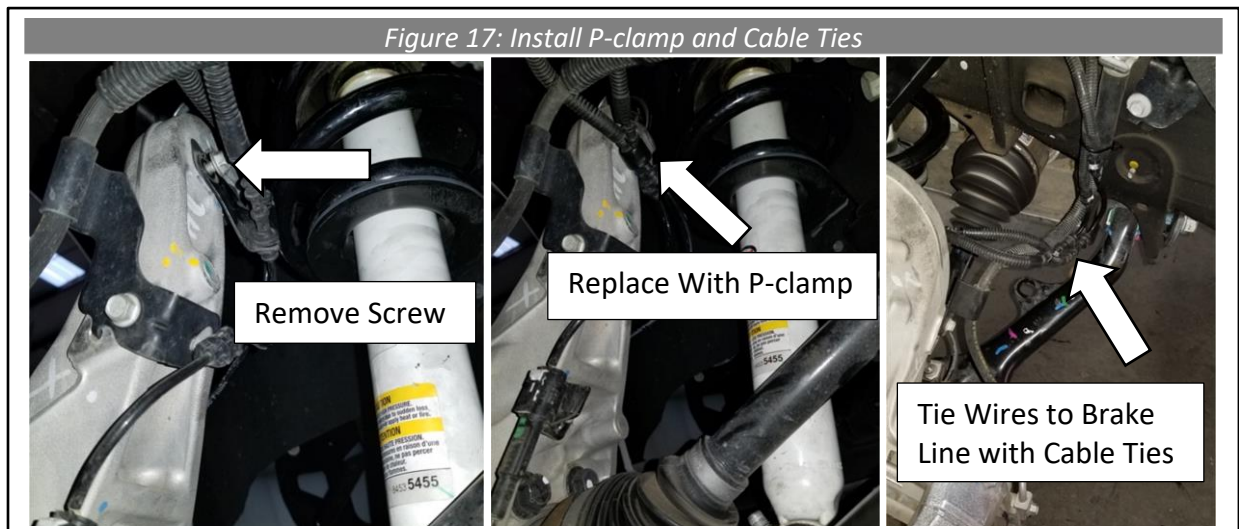

21. If there were factory lines mounted to the factory upper control arms such as ABS or brake lines, they must be restrained as to avoid binding and contact with any moving parts of the vehicle. Use cable ties to restrain the ABS line to the brake line on the passenger side. The driver side may have an additional line for the brake pad wear sensor and can be tied to the brake line as well. Make sure the Cognito arm and shock is fully installed and the suspension is at full droop. Check that all tied lines are free of stress during the complete steering cycle. After the wheels are back on and the truck is sitting on the ground, check this again. Be sure there is no rubbing or loose cables anywhere.
22. Adjust the headlights per owner's manual, we find that 2.5 turns is pretty good.
23. If any parts other than OEM or parts provided in this kit **110-90766**, the max ride height must be checked (reference figure 18 and Table 1). Lift the truck so that the front wheels are off the ground ensuring the suspension is at full droop. Put a piece of masking tape at the top of the wheel well directly above the center line of the wheel. Take a measurement from the taped mark to the top of tire and record it as (A) in table 1. Subtract 3 inches from A and record this number as (B). Set the truck back on the ground, drive it backward 15-20 feet, then forward to the starting point so the suspension settles out. Record this measurement from the same point on the tape to the top of tire again and record it as (C).

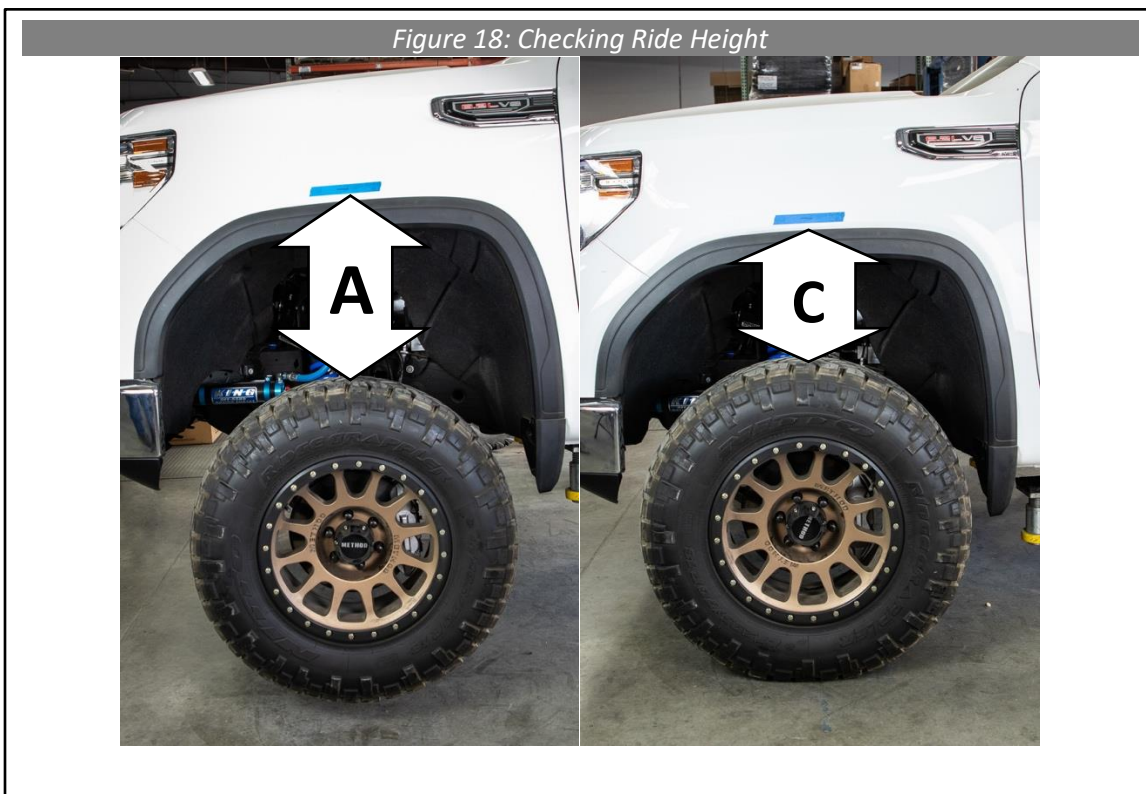

Table 1

Full Droop	A	
Max Ride Height	B = A - 3	
Current Ride Height	C	

If (C) is larger than (B), the ride height is too tall. This can be caused by shocks that are too long, too tall of a shock spacer, stacked shock spacers, spring preload devices, or any combination of the above.

24. Have the vehicle’s front end professionally aligned using these front end alignment guidelines:

Some Cognito upper control arms have added caster built into them to increase drivability performance, therefore it’s important to be sure the correct control arm is installed on the correct side of the vehicle. It’s also important to make your alignment shop aware that if caster is higher than normal for OEM, that is the intention by design.

Cross caster is important in making your vehicle track straight down the road. Most roads have crown to them, high in the middle for water runoff. This crown will make your vehicle want to pull to the right. Vehicles with stock tires on them have a narrow contact patch on the ground and are not as affected as a vehicle having larger wider tires. With larger wider tires it’s important to have cross caster proper in order for the vehicle to track straight on these roads. Trucks with dual rear wheels have more tire on the ground and require more cross caster. The length of the wheelbase will also affect cross caster needed.

Generally, crew cab short and long bed trucks like .8 degrees of cross caster. For example, the driver side would have 2° while the passenger side would have 2.8° of caster. Dual rear wheel trucks like .9-1.0 degrees of cross caster. Your area might have roads that are crowned more or less than average therefore these numbers may need to change and your alignment shop should understand this. If your alignment tech is stating they can’t align the truck, that typically means they can’t get the alignment to OEM spec, and that’s fine because your vehicle is no longer OEM. A good tech will understand this and the numbers and let caster run slightly out of OEM spec (Caster should always be above 2 degrees positive) while maintaining cross caster needed for the vehicle and roads so you enjoy your vehicle with aftermarket Cognito parts and your driving experience. Camber should always be from -.1° to +.1° and toe should always be .125” to .250” toe in for best tire wear.

WARRANTY / RETURN POLICY / SAFETY

Cognito Limited Lifetime Warranty

Cognito Motorsports, Inc. hereinafter “Cognito,” warrants to the original retail purchaser, that its suspension products are free from workmanship and material defects for as long as the purchaser owns the vehicle on which the product(s) were originally installed. This warranty will be void if any modifications are made to the components, including alterations to the surface finish, i.e.; painting, powder coating, plating, and/or welding, or if they are improperly installed. Cognito truck suspension products are not designed nor intended to be installed on “competition” vehicles used in race applications, stunt or for exhibition purposes that are outside of the intended operating conditions specified by the manufacturer. Racing and competition are defined as any contests between two or more vehicles; or vehicles competing individually on off road circuits in timed events (whether or not such contests are for an award or prize).

This warranty does not include coverage for police, taxi, government or commercial vehicles, and the warranty does not cover Cognito products sold outside of the USA. Cognito’s obligations under this warranty are specified and applied at its sole discretion, and warranty coverage is limited to repair or replacement of the defective product(s). Any and all costs of removal, installation or reinstallation; freight charges, incidental or consequential damages associated with the covered products are expressly excluded from this warranty.

The following items are exempt from Cognito limited warranty coverage: bushings, bump stops, tie-rod ends (Heim joints) and limiting straps. These parts are “consumables” and designed to wear as a normal part of their duty cycle, therefore they are not considered defective when worn. The aforementioned products are warranted separately against defects in workmanship, for 60 days from the date of purchase. As a condition of warranty validation, respective Cognito suspension components must be installed as a complete system (not combined with non-Cognito hardware or ancillary parts). Any substitutions or omission of required components will void the warranty. Some minor cosmetic wear and imperfections may occur to parts during shipping, which is not covered under this warranty. This limited warranty does not apply to any components that have been subjected to collision damage, negligence, alteration, abuse, or misuse, and coverage does not extend to products manufactured by third-party companies. Cognito reserves the right to supersede, discontinue, or change the design, finish, part number and/or application of its parts when deemed necessary, without notice.

Return Policy

Product returns will not be accepted without prior written approval from an authorized Cognito representative. All products being returned must be shipped via trackable, prepaid freight. Returned products are subject to a 25% percent restocking fee. The eligible return period for products purchased directly from Cognito is 30 days from the verified date when the product(s) were originally received by the purchaser.

Product Safety Advisory

The installation of Cognito steering and suspension components will modify your vehicle’s original factory equipment and geometry, which may cause it to handle differently than a stock (unaltered) vehicle. Installation of these components is not intended to strengthen nor reinforce the vehicle’s frame, nor are they designed to increase rollover protection. It is necessary to periodically inspect all suspension and drive train components for proper attachment, torque specifications, operation, and for any potential unusual wear or damage. Installation of these parts will modify the height of the vehicle and may raise the center of gravity. Modifying vehicle height combined with off road operation may increase your vehicle’s susceptibility to rollover conditions, which may cause serious injury or death. Many states regulate allowable vehicle height modifications, and it is your responsibility to know and comply with the legal requirements specified by the laws where you reside. Modifications to your vehicle’s ride height may also affect the ride quality, driver input response, trackability and handling, and wear to your vehicle’s suspension components and tires.