



**DOWNLOAD THE LATEST
INSTALL MANUALS AT
www.bddiesel.com**



5.9 CUMMINS VGT KIT

**Converts a Common Rail 5.9 to use a VGT Turbocharger
2003-2004 Auto trans / 2005-2007 Auto & Manual**

1047135	Controller Kit Includes all electrical parts only
1047136	Install Kit with Controller Includes everything but the turbo
1047139	Stock HE351 VGT Turbo Kit Complete kit with 60mm VGT
1047140	Screamer VGT Turbo Kit Complete kit with 64.5mm VGT

Controller Kit Contents (included in all kits)





<p>1407036</p>	<p>1407037</p>	<p>1407038</p>
		
<p>VGT Control Module Qty: 1</p>	<p>VGT Control Harness Qty: 1</p>	<p>Exhaust Brake Switch Kit Qty: 1</p>

<p>1407130</p>	<p>1407131</p>	<p>1407132</p>
		
<p>03-04 APPS Adapter Qty: 1</p>	<p>05-06 APPS Adapter Qty: 1</p>	<p>07 APPS Adapter Qty: 1</p>





<p>1300348</p>	<p>1453240</p>	<p>1300131</p>
		
<p>Posi-Tap Qty: 2</p>	<p>Wastegate "fooler" Qty: 1</p>	<p>Tie Wraps Qty: 12</p>

Install Kit Contents (included in 1047136/7139/7140)



1045966	1045992	1405100
		
5.9 VGT Manifold Qty: 1	Manifold Gasket Set Qty: 1	Turbo Exhaust Clamp Qty: 1

1900033	1453104	1407034	1405101
			
Rear Manifold Plate Qty: 1	Oil Drain Tube Qty: 1	Bracket; Coolant Tube Qty: 1	Exh Elbow Qty: 1

1200208	FT-11115722	1462430	1462431	1462441
				
1/8" NPT Plug Qty: 3	M8-1.25x12 Bolt Qty: 2	M10-1.5 Long Stud Qty: 6	M10-1.5 Short Stud Qty: 2	M10-1.5 Nut Qty: 9

1900075	1302196	1407024	1407033
			
5/8" Heater Hose Adapter	Clamp; CTB 24	Fitting; -6JIC to M18	3/8" Barb to 1/4" NPT
Qty: 1	Qty: 2		Qty: 1

1604053	1407032	1407029
		
3/8" Hose	-6JIC to 3/8" Barb 90deg	-6JIC to M16 Banjo
Qty: 18"	Qty: 1	Qty:

1407028	1900014	1407023
		
Bolt; Banjo M16	Nut; M8	Drain; Coolant -6JIC
Qty: 1	Qty: 2	Qty: 1

1505001	1405976	FT-0424606
		
Clamp; Gear	M10 Spacer	O-ring; Viton 2mmx16mm
Qty: 2	Qty: 2	Qty:1

VGT Turbo (included in 1047139/7140)



Optional Items (Sold Separately)

Adapter wire to convert HE300VG to HE351VE turbocharger plug PN: 1407046
Only needed when using 2013+ style turbo with this controller kit.



Table of Contents

Controller Kit Contents (included in all kits)	2
Install Kit Contents (included in 1047136/7139/7140)	3
VGT Turbo (included in 1047139/7140)	5
Table of Contents.....	5
Introduction	6
Operation	6
Removal of Old Turbo	7
Installation - Turbo and Manifold	11
Installation - Controller Kit and Wiring	19
Troubleshooting	26
Wiring Diagrams	27

Introduction

Newer 6.7L Dodge pickups have VGT turbos from factory which allow for quick spool up and built in exhaust braking capability. BD has created kits that enable you to install and control this newer style turbocharger on a 2003-2007 Dodge 5.9L engine.

The complete turbo kit (1047139/7140) includes a VGT turbo and all the parts needed to install it including a controller. This turbo spools faster than a conventional turbocharger of this size and provides large performance potential.

The install kit (1047136) comes with all of the parts you need except the turbocharger. This kit is ideal for those who already have a turbo or want to use a stock sized turbocharger for faster spool with mild performance upgrades.

The controller kit (1047136) comes with only the electrical parts needed to run this type of turbocharger. This kit is intended for someone who wishes to source the installation parts elsewhere but still needs a controller for the turbocharger.

Operation

The VGT control operation is all automatic. The control module has built in look up tables and uses the various inputs (apps, boost, rpm, turbo speed) to operate the turbocharger effectively.

The VGT turbo can also function as an exhaust brake. An exhaust brake toggle switch has been included with this kit and uses the turbocharger vanes to create exhaust backpressure which will slow the vehicle down.

If the exhaust brake is turned on when the engine is cold it will close the vanes at idle to warm up the engine faster. This will operate until 180F on 2003 and 160F on 2004-2007 trucks.

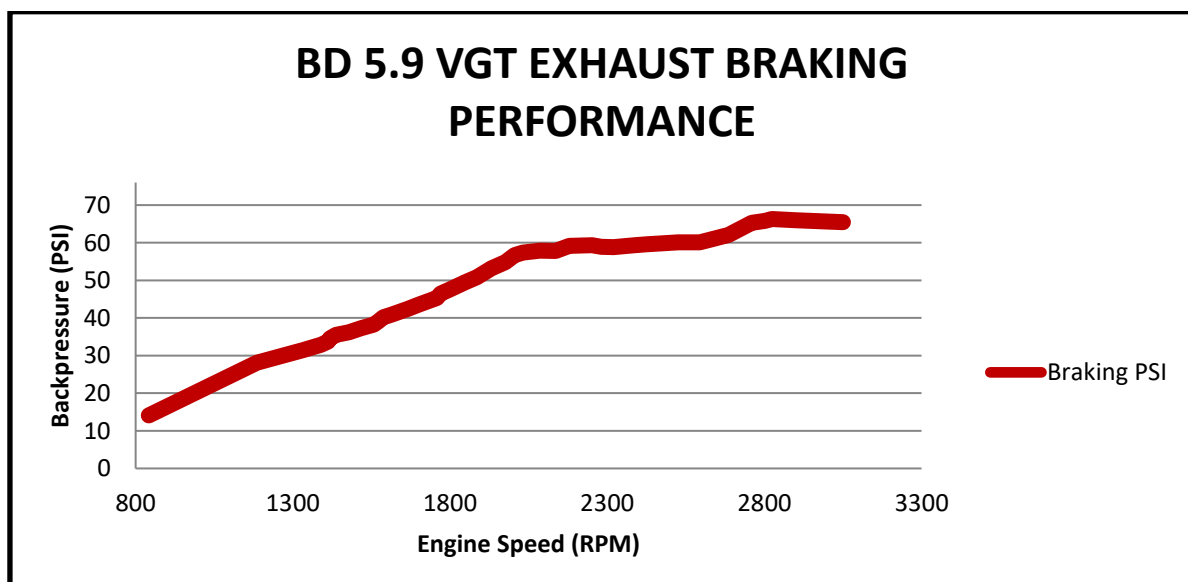

BD Engine Brake Inc.

Plant Address: 33541 MacLure Rd. Abbotsford, BC, Canada V2S 7W2

U.S. Shipping Address: 1124 Fir Avenue, Blaine, WA 98230 | U.S. Mailing Address: P.O. Box 231, Sumas, WA 98295

Phone: 604-853-6096 | Fax: 604-853-8749 | Internet: www.bddiesel.com

Removal of Old Turbo

Disconnect batteries
Disconnect the IAT sensor from the air intake



Remove the intake hose



Remove the passenger side inner fender well with a 5/16" socket.



Remove the v-band clamp from the exhaust pipe with a 7/16" socket (save this clamp - it will be reused)



Remove the turbo oil drain with a 10mm socket and pull the line out of the engine block

****Note:** Some models require you to loosen gear clamps to remove the oil drain hose.

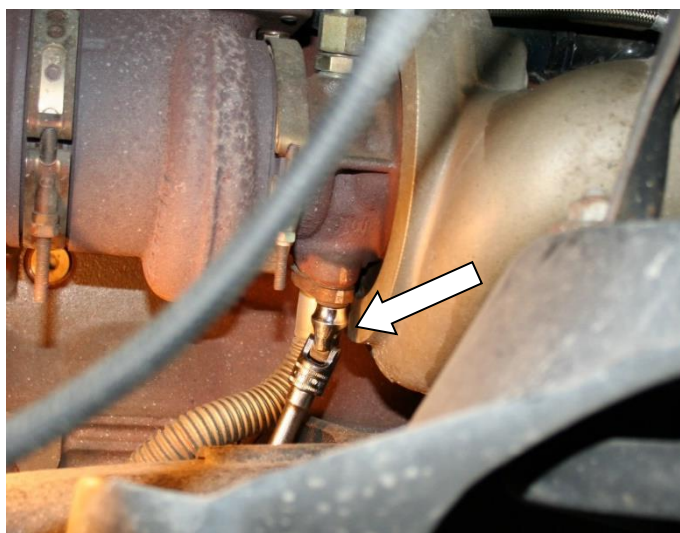

Cut the heater pipe bracket close to the manifold (leave enough of the bracket attached to the pipe to re-affix later)



Remove the turbo oil feed from the turbo



On 2005-2007 trucks, unplug the wastegate solenoid connector



Remove the passenger side intercooler hose band clamp with a 7/16" socket



Pry off the metal lock from the rear manifold bolts. Remove the heater pipe bracket.

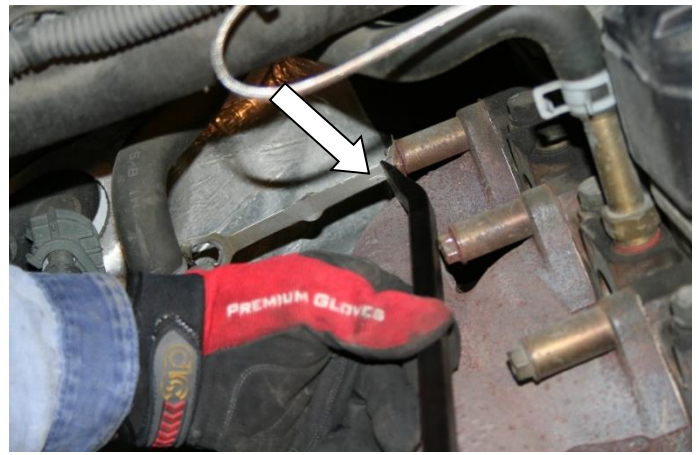

Remove the manifold heat shield with a 15mm socket



Remove the remaining manifold bolts using a 13mm socket



Remove the turbo/manifold as an assembly.
CAUTION This assembly is very heavy, you may need help lifting it out.

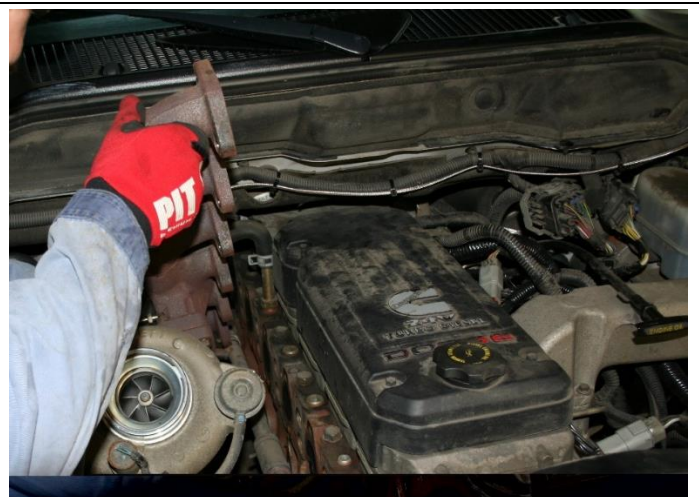

Installation - Turbo and Manifold

Install the plate (1900033) on the rear top manifold port using the 2 smaller studs (1462431), spacers (1405976) and nuts (1462441) provided in the kit (as shown).



Install 1 long stud (1462430) into the turbo flange of the manifold.

Install 2 of the longer studs in the engine as shown at the bottom of 2nd and 3rd port from the back of the motor.

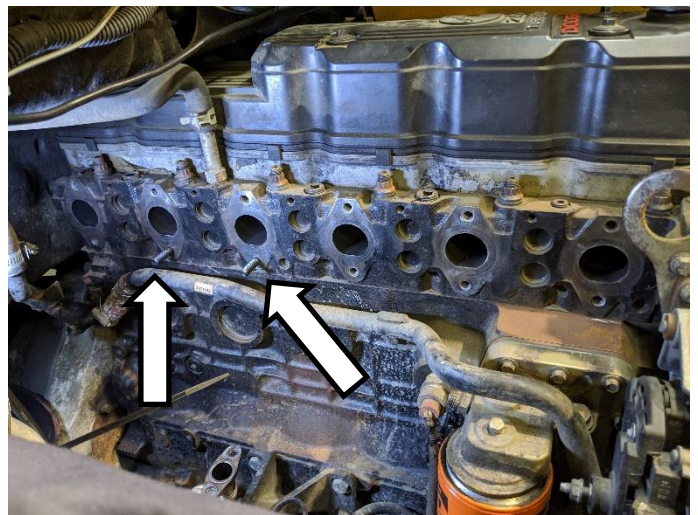

Remove the coolant port plug, towards the front of the engine on the passenger side.

Install the supplied FT-0424606 O-ring onto the 1407024 ORB to JIC fitting.

Install fitting into the engine block as shown



Loosely install the Banjo to JIC fittings in the bottom of the turbocharger.

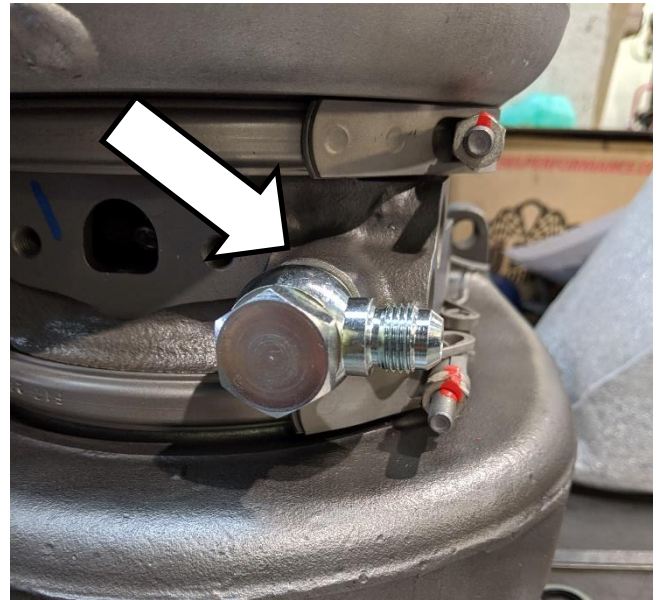

Loosely install the coolant line (1407023) as shown.

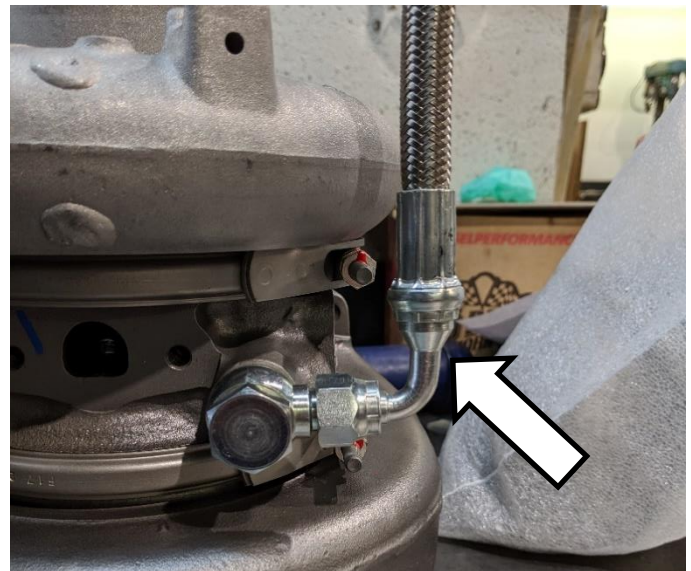

Install the 2 remaining studs onto the turbo.

Transfer and secure the oil feed fitting from your stock turbo onto the VGT.

Drop the turbo into the engine bay.

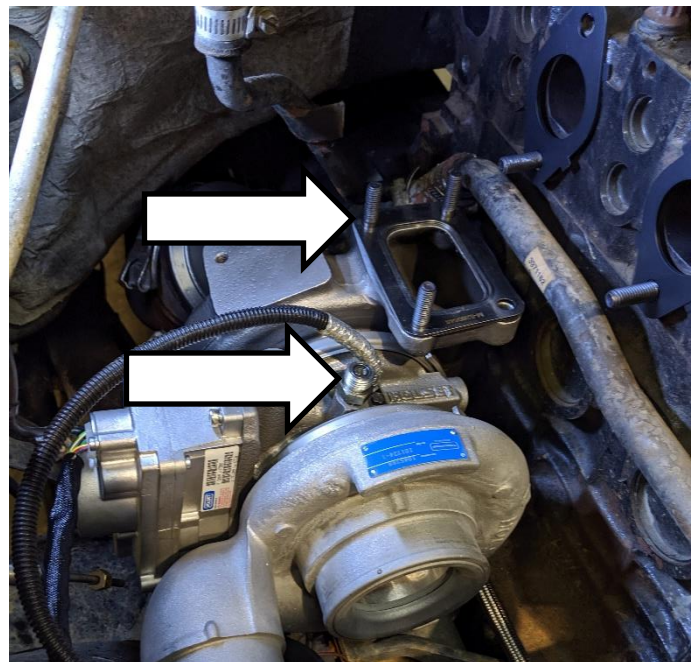

To help ease the installation of the manifold, it may be useful on 05-07 trucks to loosen the coolant tube and slightly shift out of the way.

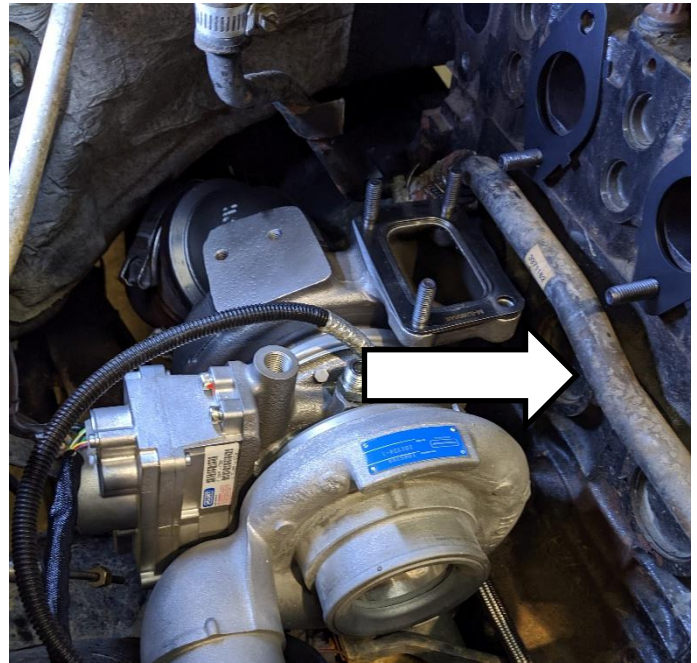

Install the manifold and gaskets onto the engine and turbo. Torque manifold bolts and nuts to 33ft-lbs.

Secure the turbo to the manifold. Torque the turbo mounting nuts to 32ft-lbs.



Secure the coolant line to the JIC fitting in the engine block installed earlier.



Tighten the banjo and the JIC fittings.
Torque the banjo bolt to 18ft-lbs.



Form the supplied oil drain into shape and install onto the turbo oil drain with provided gasket. Transfer the oil drain bolt from the stock turbo.

Be sure to avoid any components coming into contact with one-another.

Torque the bolts to 18ft-lbs.

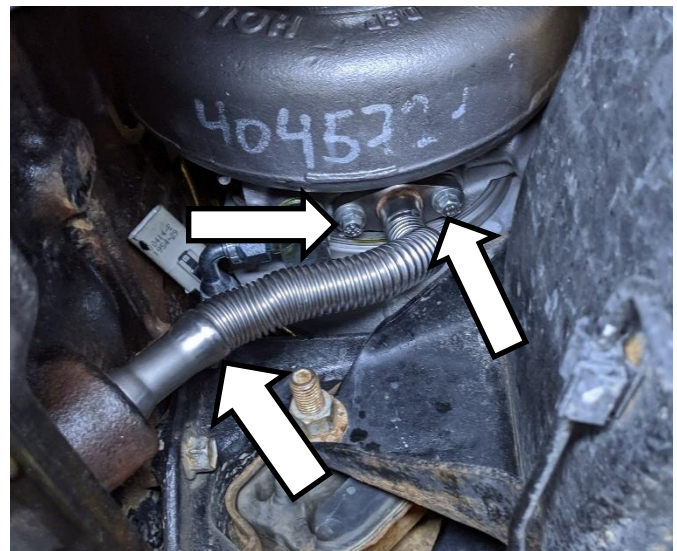

Install the banjo to JIC fitting as shown.

Torque the banjo to 18ft-lbs.



Cut the coolant hose as shown by the firewall. Do not discard the cut hose.

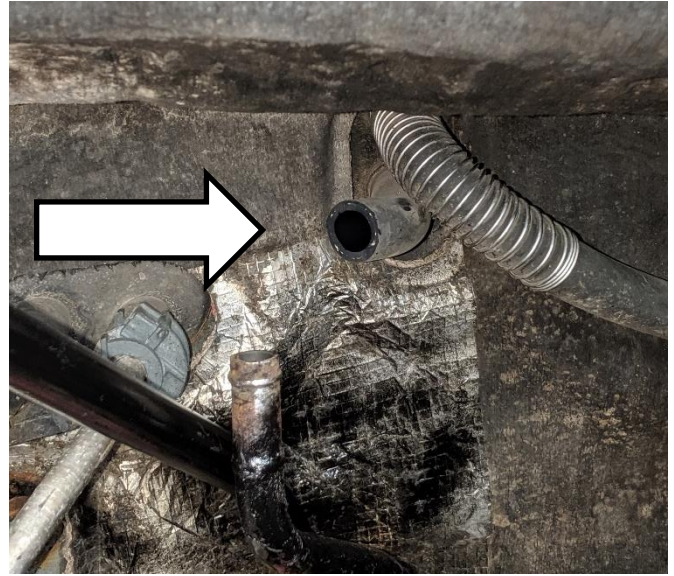

Install the supplied tee fittings (1900075, 1407033) as shown. Secure both sides with supplied spring clamps.

Install the supplied 3/8" hose to the barb and secure with gear clamp.

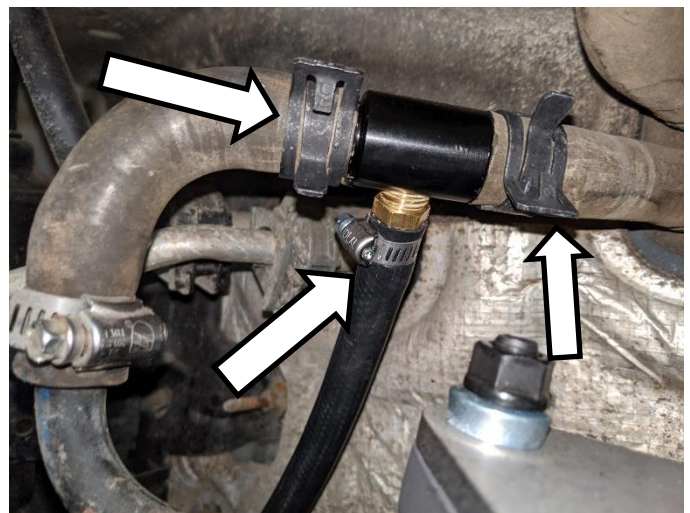

Install the JIC to Barb fitting. Secure the hose onto the fitting.

Tighten the JIC fitting onto the banjo.

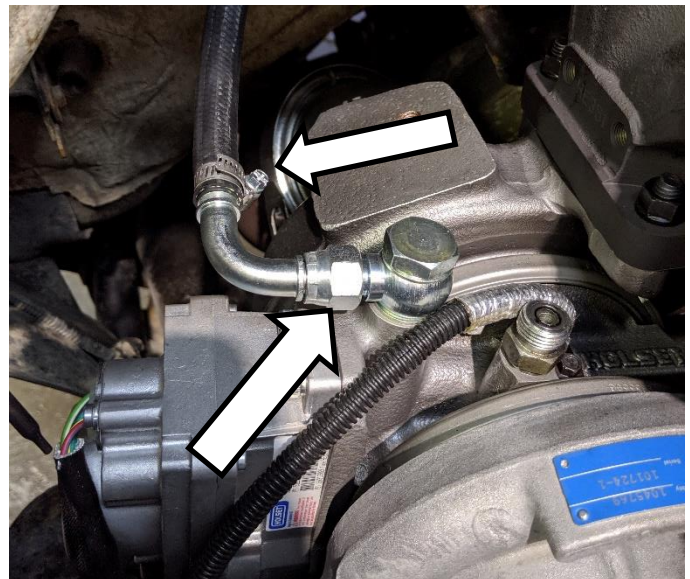

Install the two NPT plugs into the manifold if not using ports.

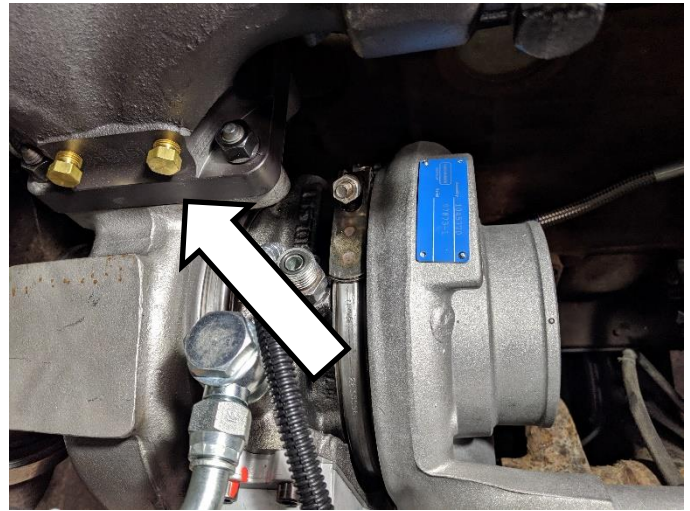

Secure the coolant line to the manifold using the provided bracket.

Mockup the bracket to the manifold stud and coolant tube tab and drill $21/64$ " or M8 bolt clearance hole at the marked location on the coolant tube tab.

Secure the bracket to the manifold with the provided nut and to the coolant tube with the provided nut, bolt and washers.

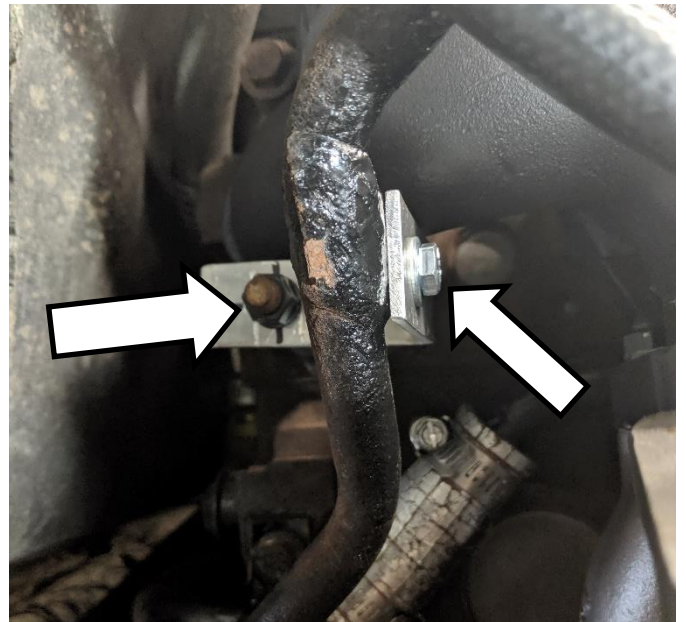

Install the provided exhaust outlet elbow to the turbo and the exhaust downpipe. Reuse your stock downpipe clamp. Turbo to exhaust elbow clamp is provided in the kit.

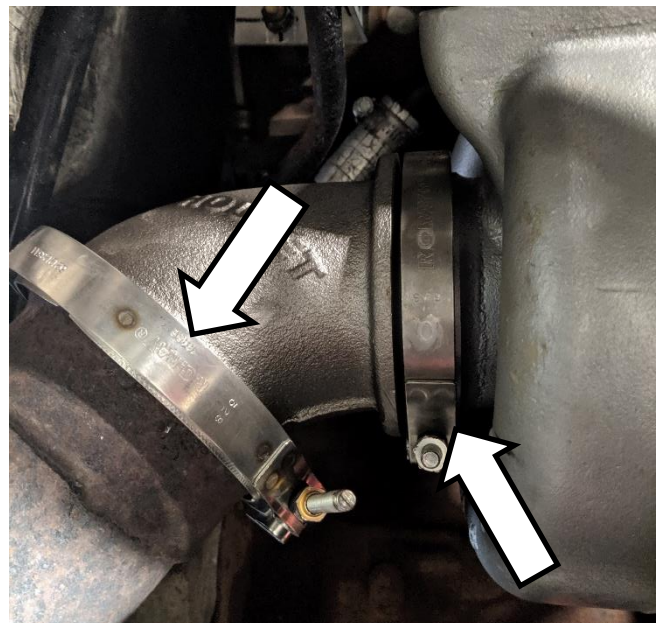

Refer to the Installation – Controller Kit and Wiring section of the manual to successfully connect the turbo to the supplied electronics before proceeding forward.

Turbo actuator and speed sensor should be connected following the wiring instructions.

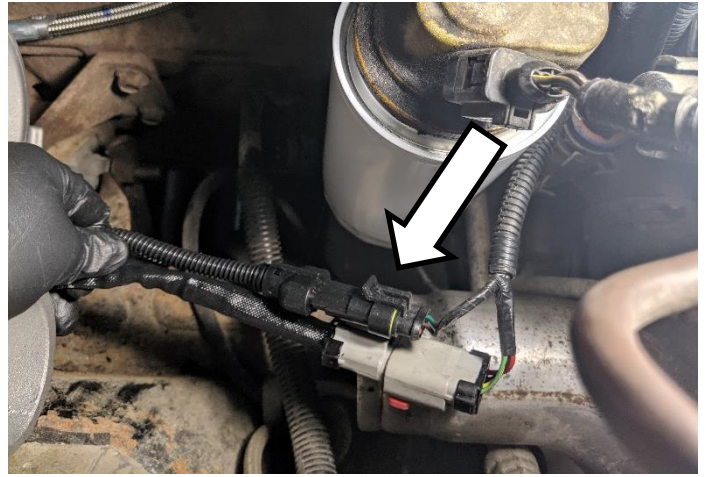

Install the oil feed line. Tighten at both ends.



Install the boot at the turbo outlet and re-install your intake system and airbox.

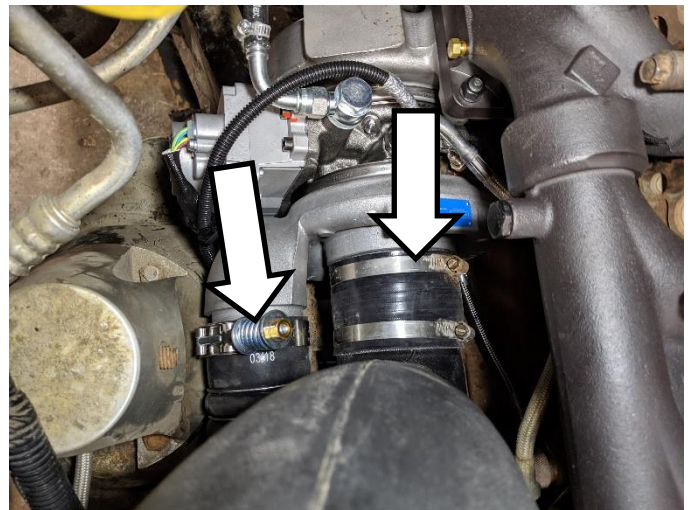

Connect the IAT sensor.

Reinstall the inner fender well.

Refill coolant as per factory instructions.

Connect batteries.



Installation - Controller Kit and Wiring

Disconnect both vehicle batteries before installation for safety.

Install the main VGT control harness in the engine bay. Line up the various plug in locations before securing the harness in place. Follow the factory engine wiring harness. This will require fishing the two turbo electrical connectors across the front of the motor and down the passenger side behind the oil filter.

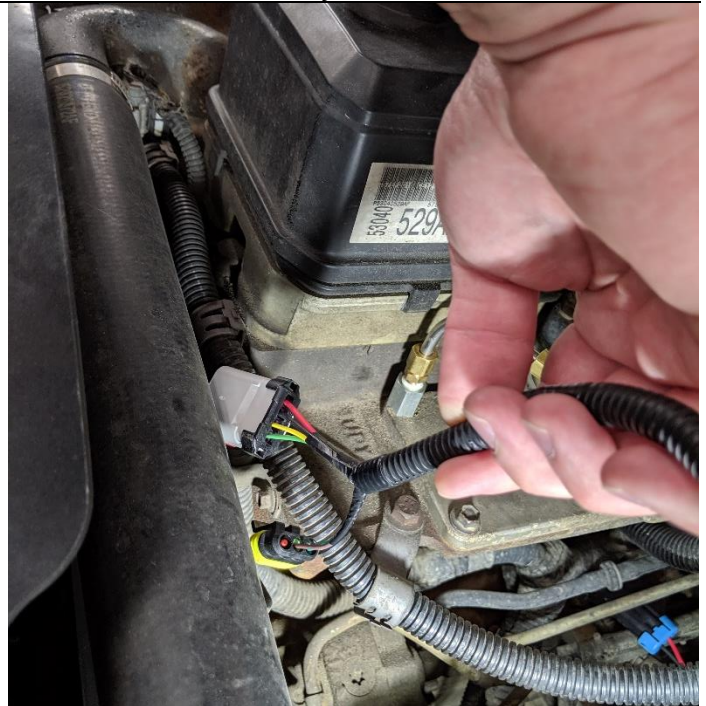

Connect the turbocharger actuator and the turbocharger speed sensor wires to the turbo.

NOTE 2013+ HE300VG turbos require an adapter wire (sold separately)



2004-2007 Models
Connect the main harness to the coolant temperature sensor by plugging it inline.

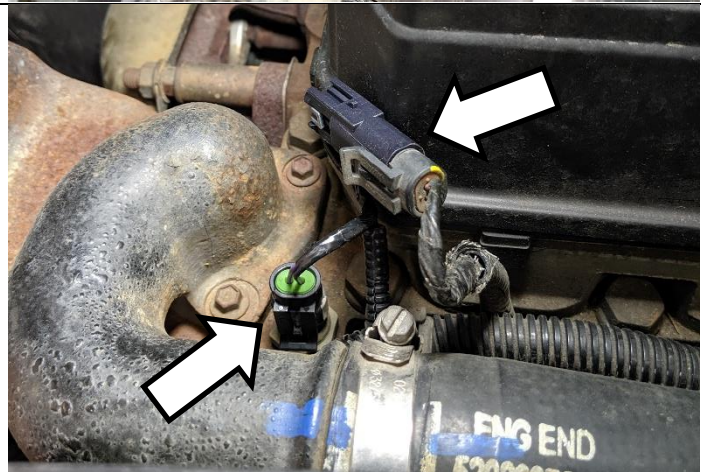

2003 Models

Cut the two-pin coolant temperature sensor connector off of the BD harness and use a posi-tap to connect to your factory coolant temperature sensor signal wire.

Pin 2 – TAN/BLACK

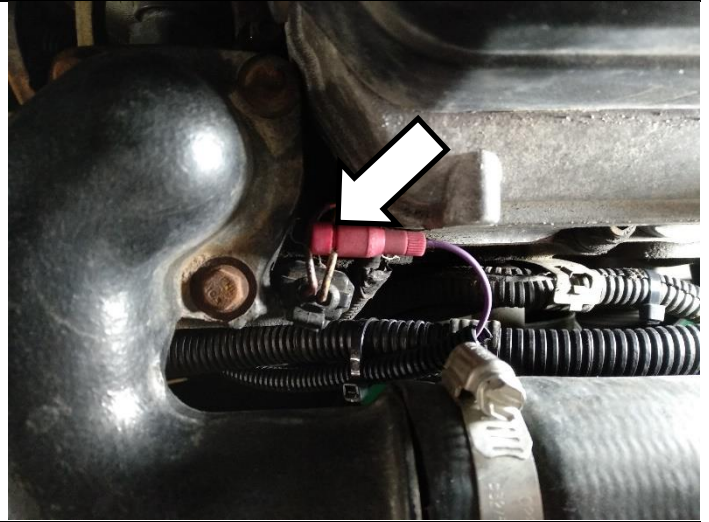

Connect the main harness to the engine MAP sensor located on the intake manifold plate by plugging it inline.

IMPORTANT If the vehicle has a “boost fooler” device, connect the VGT kit directly to the MAP sensor side so it still gets the correct reading.

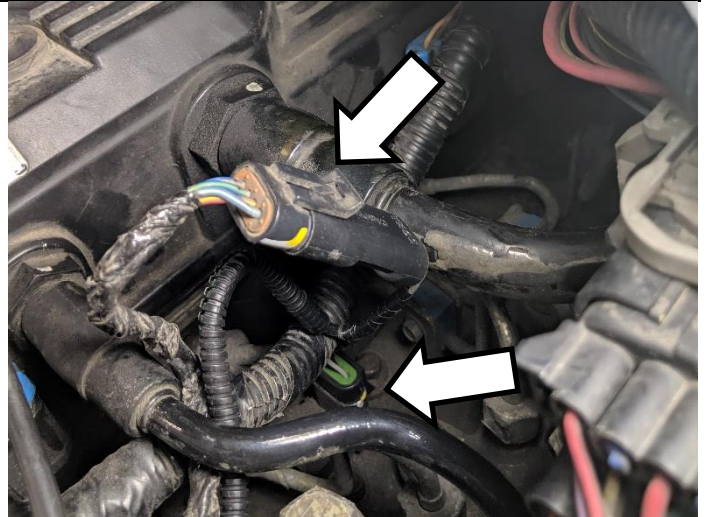

Connect the main harness to the vehicles crankshaft position sensor by plugging it inline.

NOTE do not mix this up with the camshaft position sensor



Connect the main harness to the fuel bowl heater by plugging it inline. This provides power to the kit

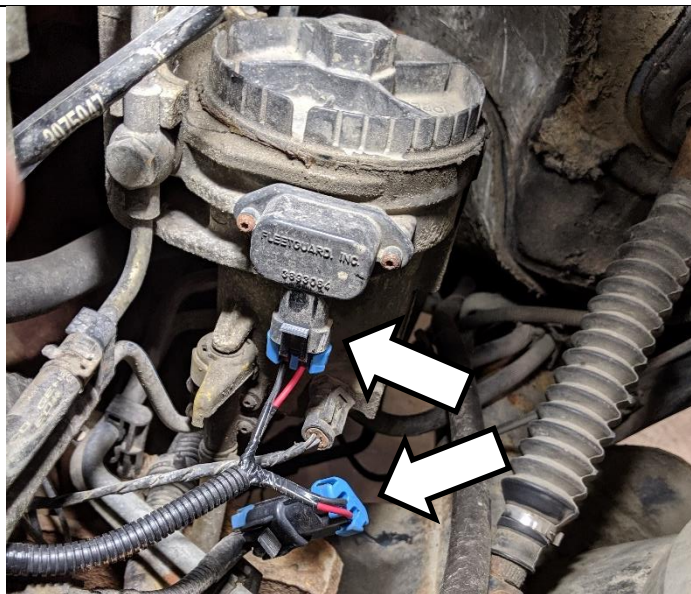

Choose the appropriate accelerator pedal position sensor adapter harness (1407130/31/32) for your model. Install this in line with the sensor.

(2003 shown)



Connect the main harness to the accelerator pedal position sensor adapter installed in the last step. If this is inside the vehicle cabin (2005+) route this wire through the firewall.

(2007 shown)



Route the RED and PINK wires from the toggle switch kit (1407038) from inside the cab to under the hood near the VGT control module.

Wires can pass through either the main wiring harness bulkhead or through the clutch cylinder block off plug.

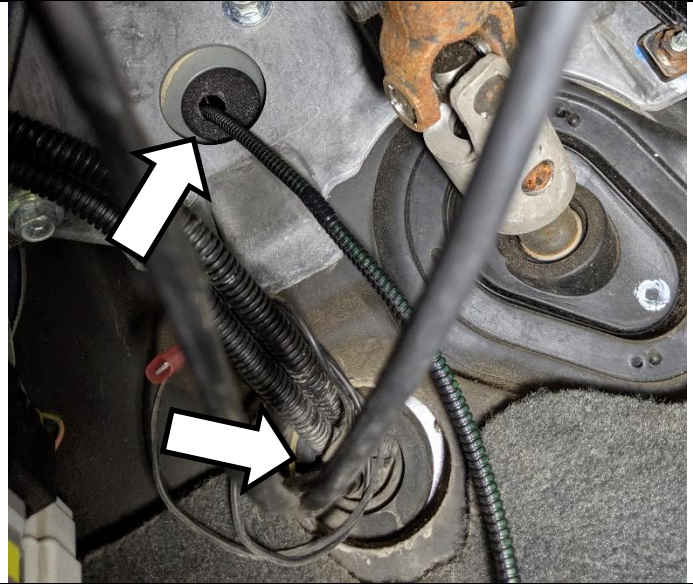

Locate the gray 12 pin module plug from the VGT control kit. Remove the orange wedge using needle nose pliers.



Remove the two seal pins in pins 10 and 11 by pulling them out the back with a pick or small screwdriver.



Insert the RED wire into pin 10 and the PINK wire into pin 11. Ensure the pins latch into position. Reinstall the wedge lock by pushing it back into the connector.



2003-2004 Models

Verify the switch wire pinout matches the configuration for these models. The violet and brown wires will not be used. Connect the ground wire (black) to a ground under the dash by removing and reinstalling a screw.

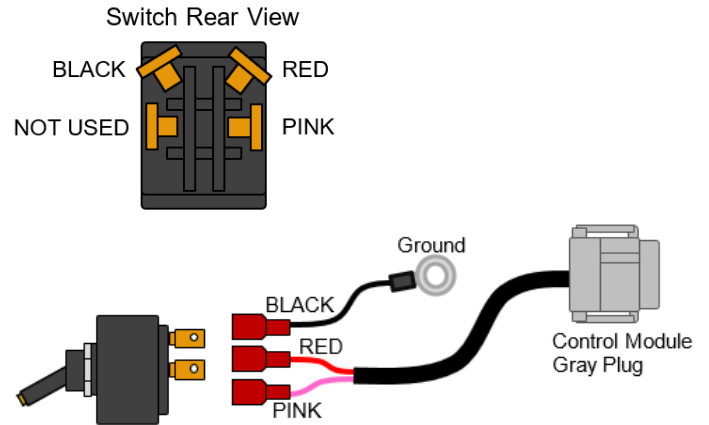

2005-2007 Models

Verify the switch wire pinout matches the configuration for these models, you may need to remove the black wire from the switch to install the violet and brown wires. (The black wire is not used for these vehicles). The violet and brown wires are the cruise disable wires. It is necessary to disable the cruise control when the brake is operational on these years as the cruise control function is internal to the ECM and does not move the accelerator pedal with a servo.

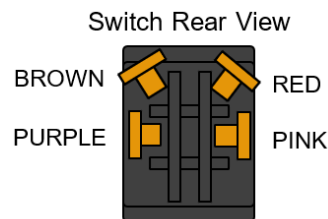

Remove the steering column lower cover by removing the T20 Torx screws securing the tilt lever and the column covers. Locate the 6-pin white connector behind the clock spring, this has the cruise control wires we will attach to.

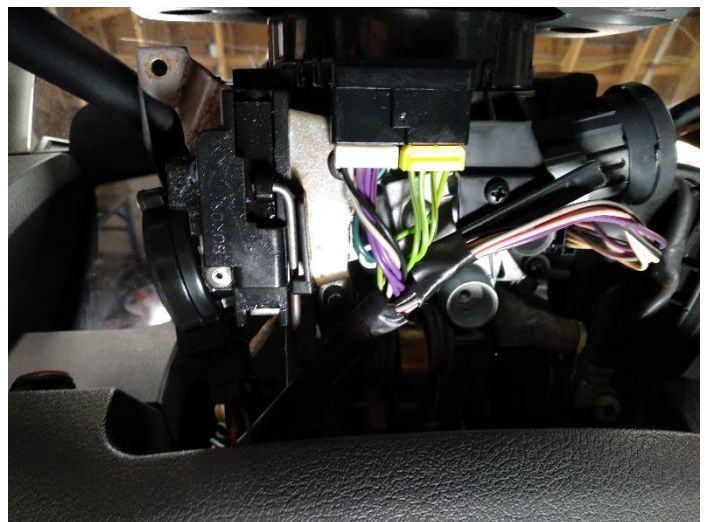

WARNING Do not tap into the YELLOW connector wires; these are for the airbag.

Locate the VIOLET wire (PIN 4) and install a positap. Then connect this to the VIOLET wire from the toggle switch. Locate the VIOLET/BROWN wire (PIN 5) and install a positap. Connect to the BROWN wire from the toggle switch.

Reinstall column covers.

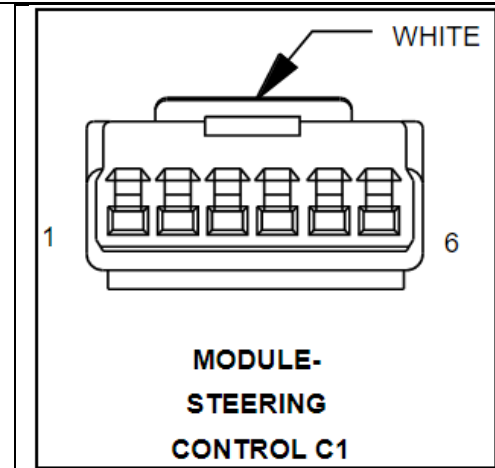
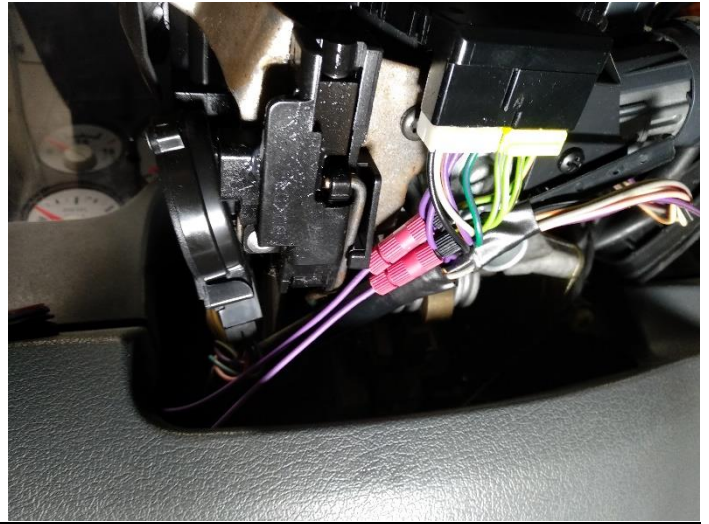
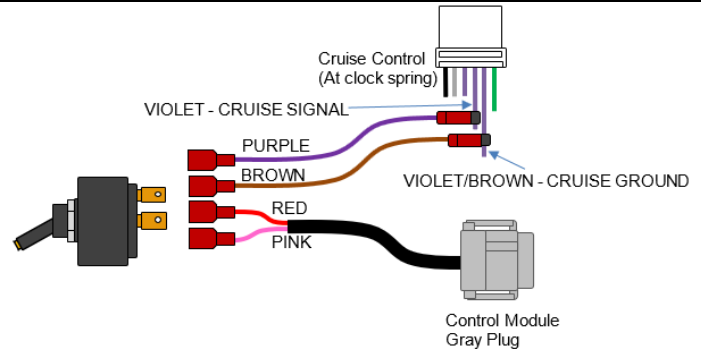

Clock spring C1 (WHITE) Pinout (2005-2007)

1	BLACK
2	GRAY/WHITE
3	VIOLET/ORANGE
4	VIOLET (Cruise Control Signal)
5	VIOLET/BROWN (Cruise Control Ground)
6	DARKGREEN/VIOLET

Install the switch in the preferred location. It can be mounted by drilling a hole in the dash or by using the supplied switch bracket. Install the supplied "Exhaust Brake" sticker, then install the black plastic switch mounting nut.

Connect the main harness to the control module and install the control module on the driver's side of the engine bay using wire ties.



On 2004.5-2007 trucks, install the "wastegate fooler" to cap off the unused connector for the wastegate solenoid from the stock turbocharger.



Installation is now complete. Double check all connections and start the vehicle. Check for oil leaks, coolant leaks.

Operational checks:

-Turn on the exhaust brake switch while the engine is still cold to test the warmup function – you should clearly hear this working. This will confirm turbo actuator operation, coolant temp sensor connection, accelerator pedal voltage and engine RPM.

-Once warmed up, accelerate at full throttle and ensure the turbo reaches normal boost levels (30-40psi depending on fueling/tuning). This will confirm the MAP sensor reading and turbo speed sensor output are working correctly.

If either of the above tests fail, check the troubleshooting section to determine what sensor input is not functional and to diagnose further.

-Confirm cruise control cutout operation on 2005-2007 (and 2004 manual) models only. Turn on the cruise control and ensure it is operational. Now turn on the exhaust brake switch. The cruise control should immediately cancel and begin to coast. If this does not happen turn the brake back off immediately and, check the posi-tap connection on the cruise control wires.

Troubleshooting

General troubleshooting

Poor turbo performance	<ul style="list-style-type: none"> - Oversized turbo for application/fueling - Check module inputs, may be operating in fail-safe mode - Boost leak
No exhaust brake function	Module must see BRK input from the toggle switch as well as throttle and engine speed (APP, CKP) operating normally otherwise the exhaust brake will be disabled.

The module has built in LEDs for troubleshooting. Each input to the module has a dedicated LED for diagnostics as well as fault monitoring for the turbocharger actuator.

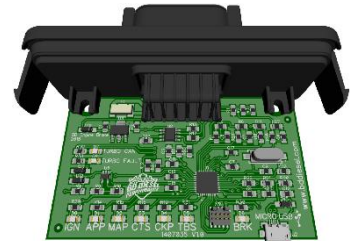

IGN	Power light. The control module is powered from the fuel heater plug and grounded through the accelerator pedal sensor wiring.
APP	Accelerator pedal sensor input. Off under 0.1v, on over 4.9v. Flashing with changing intensity between 0.1-4.9v. If this input is over 4.8v the module will command minimum boost. If this input is under 0.1v the exhaust brake will be disabled.
MAP	MAP (boost) sensor input. Off under 0.1v, on over 4.9v. Flashing with changing intensity between 0.1-4.9v.
CTS	Coolant temperature sensor input. Off under 0.1v, on over 4.9v. Flashing with changing intensity between 0.1-4.9v. If over 4.9v the exhaust brake warmup feature will be disabled.
CKP	Crankshaft position sensor input. Flashes with varying speed based on the crankshaft position sensor output. If no RPM is detected the exhaust brake will be disabled.
TBS	Turbocharger wheel speed input. Flashes with varying speed based on the turbocharger wheel speed sensor output. If no turbo speed is detected, the module will command minimum boost.
BRK	Exhaust brake switch input. Off if the exhaust brake switch is off or not connected. Flashing if the brake is enabled but not currently active. Solid when the module is commanding the exhaust brake.
TURBO CAN	Indicates communication with the turbo when flashing. If there is no turbo communication check the wiring. The turbo is powered and grounded through the fuel heater wiring.
TURBO FAULT	Indicates a fault with the turbocharger. Either due to no communication (TURBO CAN) or the commanded position of the turbo is not matching the desired position. This could be due to a defective or improperly calibrated turbocharger or actuator.

Wiring Diagrams

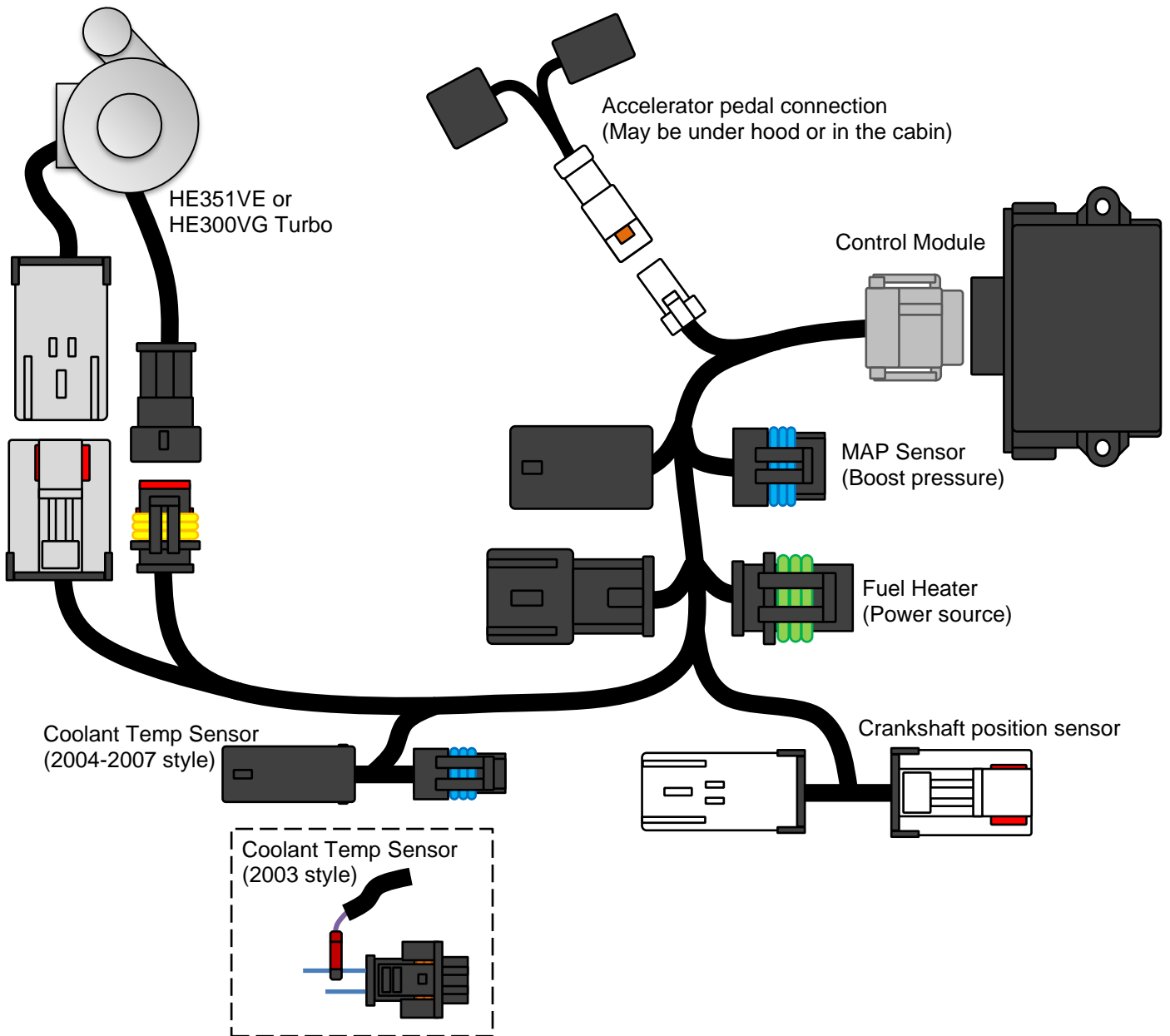

Toggle Switch Wiring

2003-2004 Automatic / 2003 Manual Transmission

Exhaust Brake Toggle Switch
(Purple and brown wires not used)

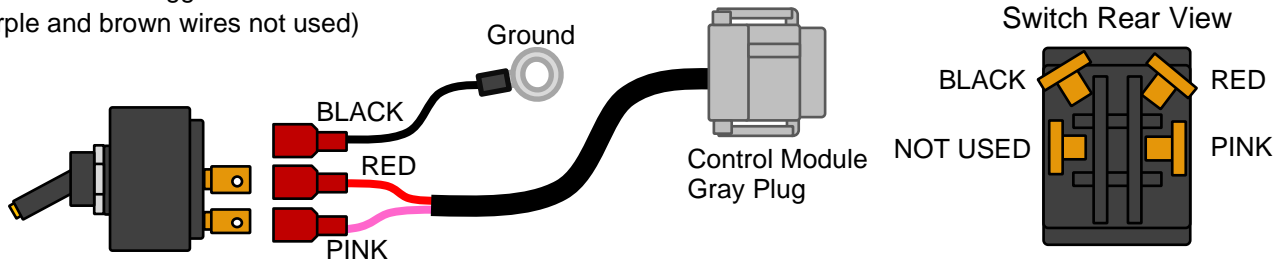

2005-2007 Automatic / 2004-2007 Manual Transmission

Exhaust Brake Toggle Switch with Cruise Cutout
(Black wire not used)

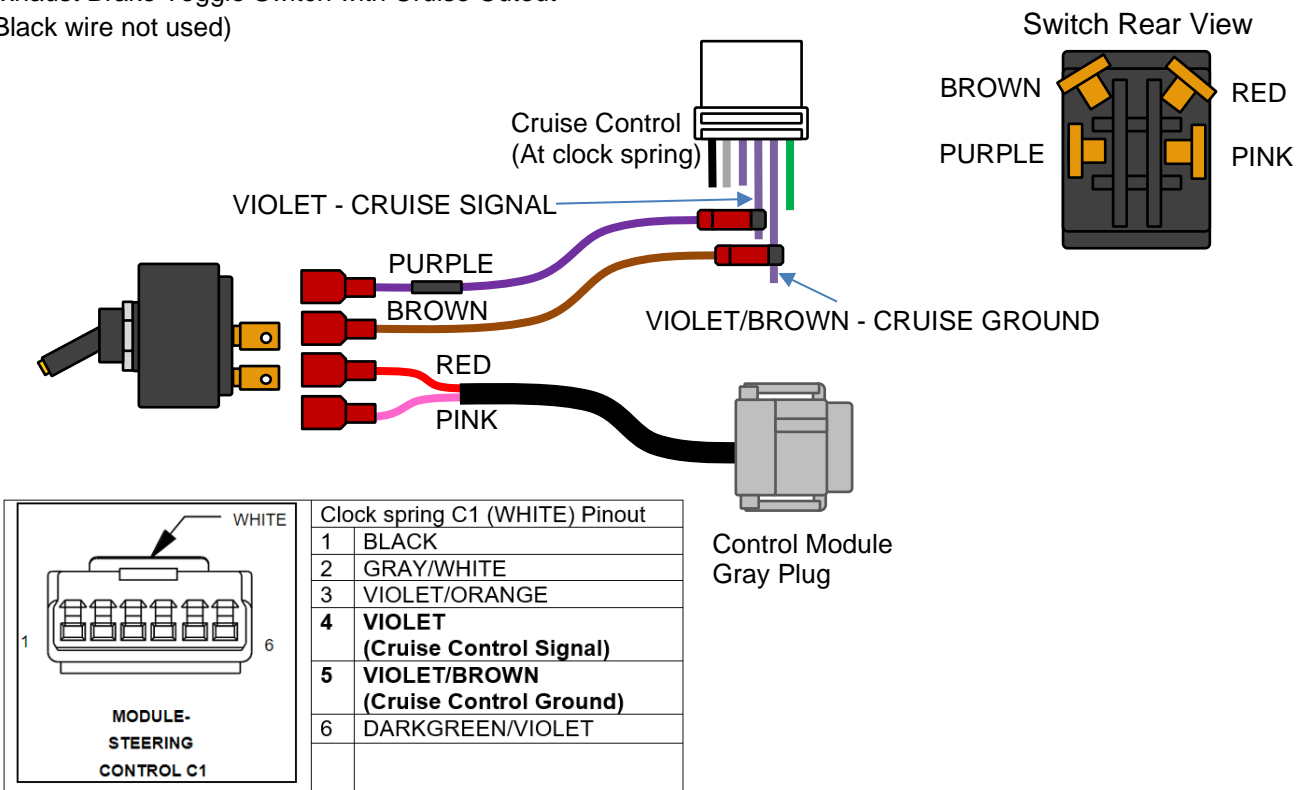

Control Module Gray Plug (All Years)
Pin 10 - Red wire (12V Output to Switch)
Pin 11 - Pink wire (Exhaust Brake Input)

