

97732 2023-2025 CHEVY/GMC COLORADO & CANYON STEALTH POD INSTALLATION GUIDE

INSTRUCTIONS

Part #s 63390

Gauge Pod

2023-2025 Chevy Colorado

2023-2025 GMC Canyon

Please read through the following instructions thoroughly before starting your installation. If you have any questions please visit



iDash Pro Sold Separately

Part Number 63390

Fits the driver side
dashboard vent found in:

- 2023-2025 Chevy Colorado
- 2023-2025 GMC Canyon



Installation Guide

What's Included

- Metal Pry Tool

- iDash Stealth Pod



If anything is missing, please call us at 800-601-8072 immediately!

Step-by-step Installation



1. With the included metal pry tool, pop off the driver-side window defroster vent.



Press down on the soft dashboard trim, slide the tool under the hard plastic vent, and pull back to pop it free.

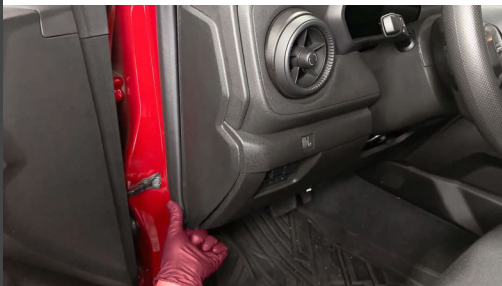

2. Locate and open the access panel to the left of the steering wheel.



Place your finger under the lower tab, then pull outward to release the clips.



This will provide extra access to route your OBD-II and data cables.

3. Run the Banks OBD-II cable from the bottom and up through to the top of the dashboard.

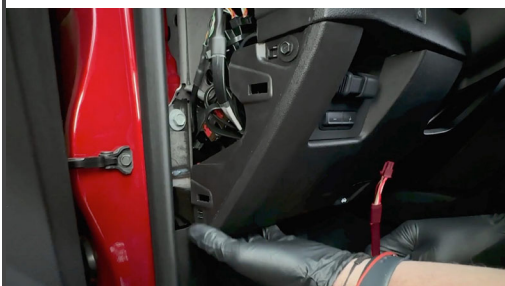

Slide the cable through the left side...

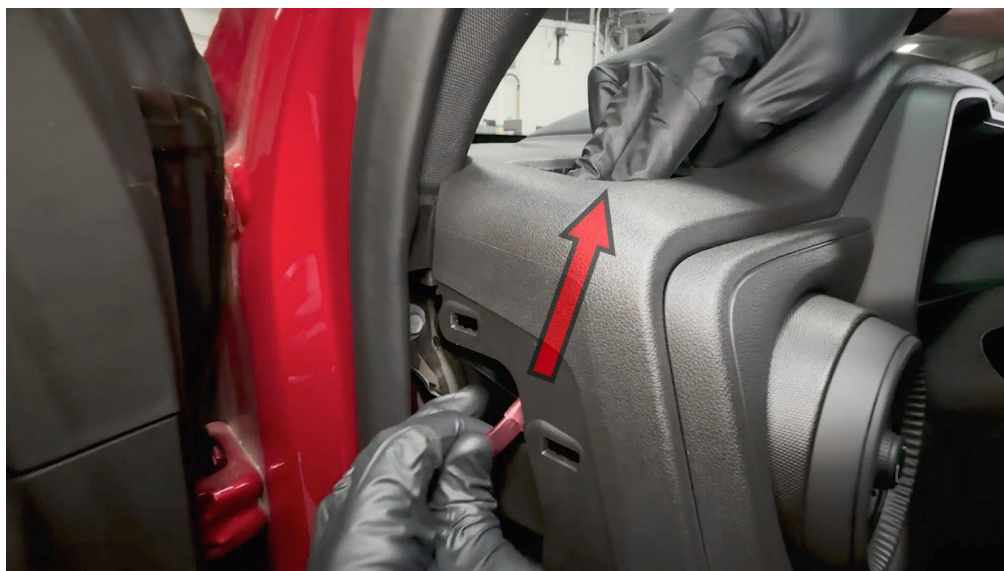

...and up to the hole in the dashboard where the vent is.

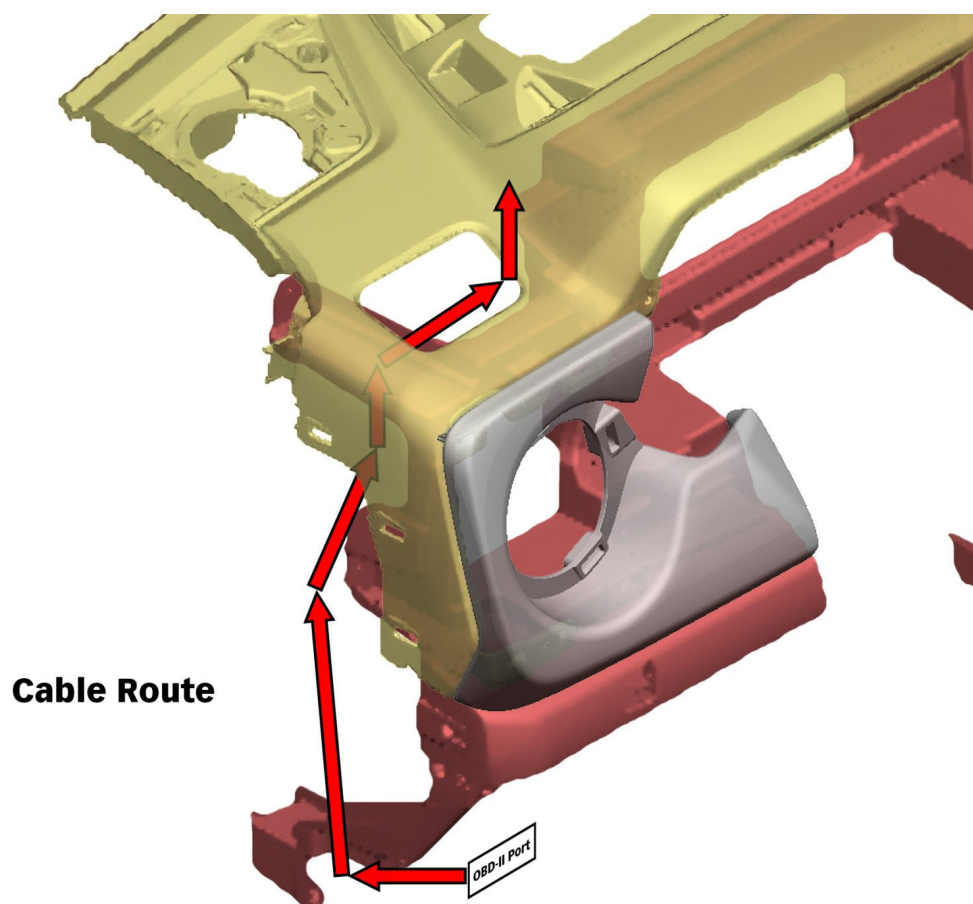

The goal is to pass the cables through a small channel

and gap that is between the metal instrument panel carrier in red, and the underside of the top of the dashboard in yellow.



The defroster duct can be pressed down slightly to allow for enough space for the small end of the Banks 4-pin OBD-II and 6-pin data cable (if using a PedalMonster) to pass through.

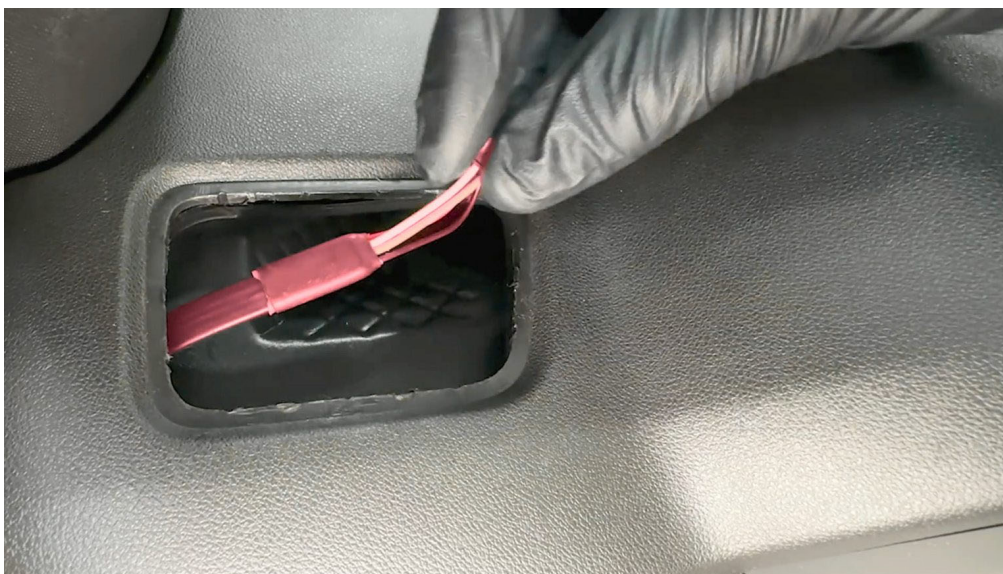

...slide the flat cable(s) past the vent duct, and out the top of the dashboard.



Route your cable(s) towards the bottom right side corner of the vent.



4. Thread cable(s) through the cable access hole in the stealth pod.

Be sure there is extra slack to reach through the Stealth Pod and connect to the iDash.



5. Slide the front of the StealthPod into place first.



6. Then snap the rear of the Stealth Pod into place on the dashboard.

Check that all the locking tabs around the base are fully seated and that the Stealth Pod is secure.

Stealth Pod Installation



7. Grab your iDash and connect the 4-pin OBD-II Cable.

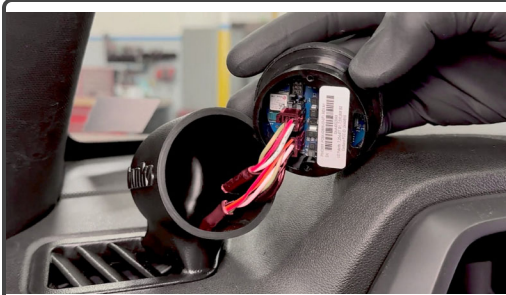

If you have a PedalMonster, connect it to the 6-Pin connector as well.

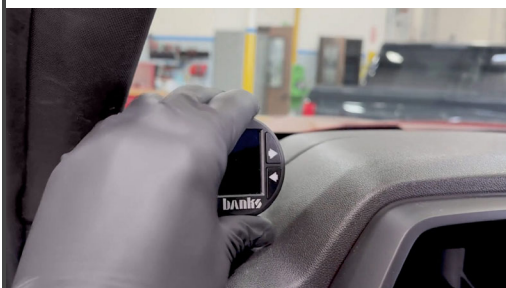

8. Install your iDash into the Stealth Pod

Be sure to clock the iDash so the Banks logo is level.



9. Tidy up any extra wire slack with the included zip ties.



10. Snap the side access pannel door back into place.



11. Connect the iDash to the vehicle's OBD-II port.



12. Check that it boots up with the vehicle, and enjoy your new Banks iDash Stealth Pod