

#52

# **AirDog® II-5G DF-220**

## **2011-2016 DURAMAX INSTALLATION MANUAL**

**PLEASE READ THIS MANUAL AND CHECK  
CONTENTS OF THE KIT BEFORE  
BEGINNING THE INSTALLATION**



CANADIAN PATENT  
2,108,391

PROTECTED BY  
US PATENTS  
5,355,860; 5,746,184; 6,729,310

AUSTRALIAN PATENT  
2005101054

NEW ZEALAND PATENT  
532356

Additional Foreign Patents Pending in Europe, South America, Mexico, Japan, and China!

# AirDog® II-5G



**SMALL and COMPACT**  
**7" Long X 3.2" Wide X 10" Tall**

## OVERVIEW

Thank you for your purchase and welcome to PureFlow AirDog's AirDog®II-5G fuel air separation and delivery system for the 2011-2016 Duramax.

The AirDog®II-5G is an all in one premium fuel pump and filtration system for the 6.6L Duramax diesel. This system removes water, particulates, and entrained air from the diesel fuel. The entrained air that is separated from the fuel is returned to the tank through a small return fitting. The fuel is delivered to the engine at the correct pressure and flow rate to meet the demands of the engine under all operating conditions.

The AirDog®II-5G DF-220 systems feature a built in adjustable diaphragm pressure regulator. All AirDog®II-5G systems include a complete installation kit.

The AirDog®II-5G, for this particular application, is preset at 8-10 psi from factory for a stock application. The regulator is adjustable up to 55 psi for fine tuning the system for performance upgrades. **WARNING: RUNNING THE PUMP ABOVE 55PSI WILL DECREASE THE LIFE OF THE PUMP SIGNIFICANTLY AND MAY VOID THE WARRANTY.**

PureFlow AirDog products are manufactured in Shelbyville Indiana by a team of skilled workers with unsurpassed attention to detail and using the most stringent quality assurance.

## HOW THE 5G OPERATES

The AirDog®II-5G DF-220 draws fuel from the fuel tank through a 5/8" suction line to reduce the risk of cavitation at the pump. The fuel is then drawn through the water separator where 92% of water is removed per SAE spec 1488. It is then pressurized through a Gerotor pump and sent to the 2 micron fuel filter before it is sent to the injection pump. The air from aerated fuel, due to tank sloshing and engine return lines, is separated and sent back to the tank through the 3/8" return fitting. The excess fuel that the engine does not use is recirculated through the diaphragm regulator back to the suction side of the pump.

## QUICK CONNECT COMPONENT OVERVIEW

Provided in this kit is an OE style quick connection system. This system works to allow for a quick, clean, and professional install.

### SAE J2044 Quick Connect System

The SAE J2044 quick connect system is the most commonly used system in the automotive industry. The images below show the formation of SAE J2044 connection. To connect the assemblies, simply insert the male end form into the mating female connector. Push firmly until you hear it “click” into place. To disconnect the fittings, press down and hold the tabs on the female connector while you firmly pull the assembly apart.



# TABLE OF CONTENTS

Section 1.....Table of Contents

Section 2.....Installation & Safety Guidelines

Section 3.....Parts List

## PUMP INSTALLATION PROCEDURES

Section 4.....Removing the Fuel Tank and Lines

Section 5.....Installing the 5/8" Draw Straw

Section 6.....Installing the Fittings in the AirDog

Section 7.....General Fuel Line Assembly

Section 8.....AirDog Suction Line

Section 9.....AirDog Feed Line to Engine

Section 10.....AirDog Return Line

## ELECTRICAL HARNESS

Section 11.....Wiring Harness

## MAINTENANCE

Section 12.....Initial Startup Procedure

Section 13.....Filter Service Recommendations

Section 14.....Cleaning the Gerotor Assembly

Section 15.....Pressure Regulator Adjustment

Section 16.....Filter Maintenance

Section 17.....Warranty Procedure

## AirDog® II-5G MODEL DF-220 INSTALLATION GUIDELINES

The installation of your AirDog® II-5G can be relatively easy by following the steps outlined in this manual, and:

1. Inventory the package components completely. Notify *PUREFLOW AIRDOG* immediately of any parts missing or damaged.
2. Read the installation manual completely. Understand how the system operates and installation recommendations before beginning installation.
3. The installation recommendations contained herein are suggested installation guidelines only. Individual installations may vary.
4. If any installation procedure is uncertain, contact *PUREFLOW AIRDOG* for technical assistance.
5. **When installing the AirDog® fuel lines be sure to keep the ORIGINAL ENGINE RETURN LINE connected as it is from the factory!**

## SAFETY GUIDELINES!

- CAUTION!** Please be sure to chock the vehicle's tires to prevent rolling.
- CAUTION!** Please use proper supports when working beneath an elevated vehicle.
- CAUTION!** Most diesel pickups have two (2) 12volt batteries. Disconnect the battery cables to both batteries before proceeding with the AirDog II installation.
- CAUTION!** Vehicle frame rails should not be drilled into or welded upon.
- CAUTION!** Wear safety glasses when operating power tools such as drills and grinders or when using a punch or chisel.
- CAUTION!** Use common sense when routing fuel lines and electrical harnesses. Keep them away from hot exhaust components and/or moving parts. Properly secure lines to prevent chaffing.

Use Good Judgment and Common Sense When Installing the AirDog®!

## AirDog® II Parts List

QTY	DESCRIPTION	PART NUMBER	IMAGE
1	AirDog® II-5G	DF-220	
1	AirDog® II Mounting Bracket	001-3C-0004	
1	Mounting Hardware Kit,	901-61-0102-PM-C-12	
1	Wiring Harness	5E-2-010-HD (11-14) 5E-2-018-HD (15-16)	
1	Bundle of Plastic Ties	5H-2-1-06/12	
1	14ft of Fuel Line	HS14	
1	7ft of 5/8" Fuel Line	HS587	
1	5/8" High Flow Suction Tube	WAP109	
2	1/2" 90° Hose Quick Connect Fitting	FQC1290	
1	11.8mm Straight Hose Quick Connect End	FQC118S	
1	3/8" 90° Hose Quick Connect Fitting	FQC3890	
1	Customer Service O-ring Replacement Kit	901-05-0500	N/A
1	1/2" Male J2004 Quick Connect x 3/4-16" UNF	08J2044-3/4UNF	
1	3/8" Male J2004 Quick Connect x 7/16" UNF	06J2044716UNF	
2	3/4-16 ORB Male to -10 JIC Female Fitting	4A-1-02-10-08-S	
2	-10 JIC Female to 5/8" Barb	4A-1-09-10-10-B	
1	-10 JIC Male to -10 JIC Female 90° Fitting	4A-2-04-10-10-S	

### ILLUSTRATION OF QUICK CONNECT COMPONENTS

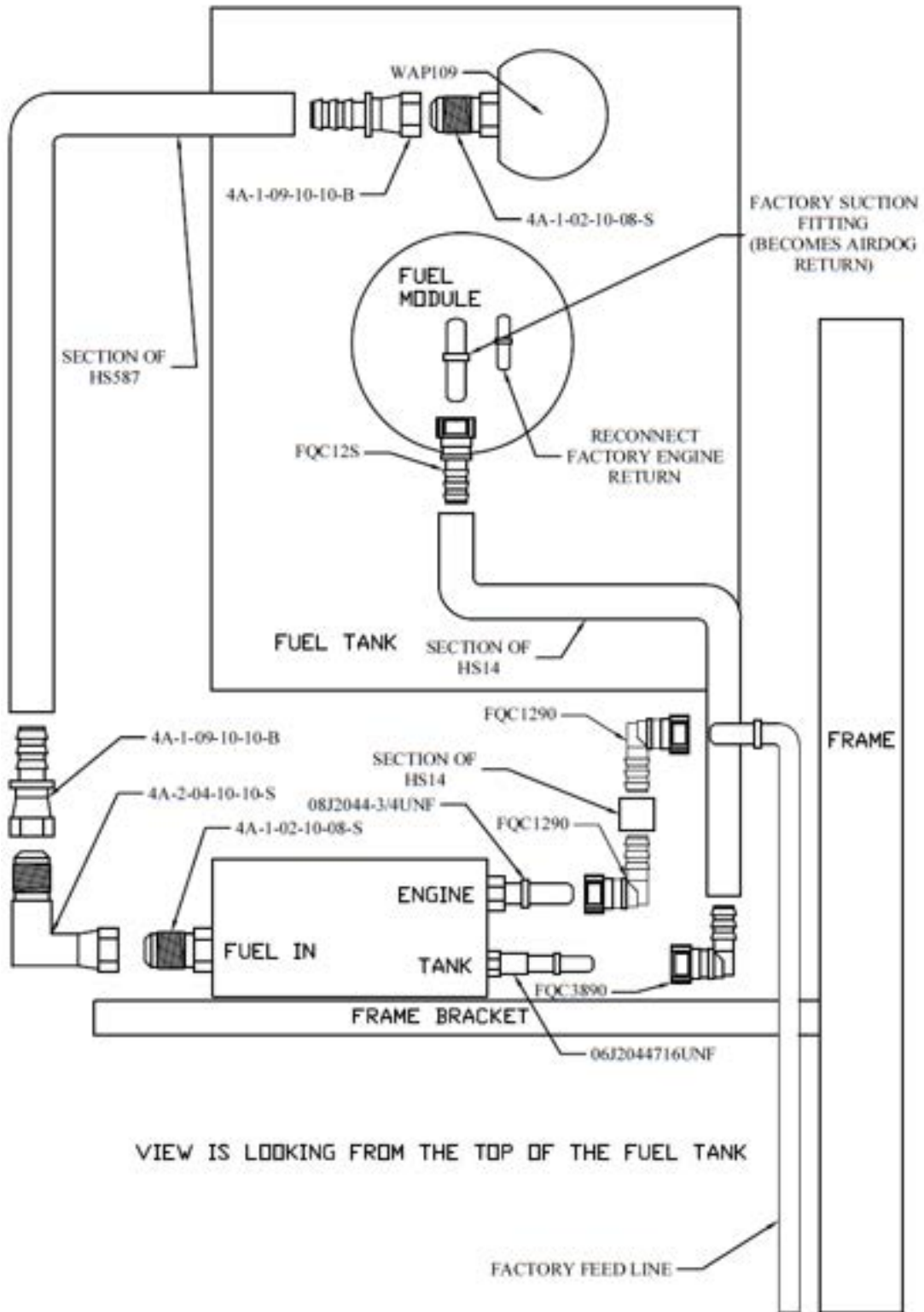



## Removing the Fuel Tank and Factory Flex Feed Line

Before any of the installation process begins, the fuel tank and the factory flexible line from the top of the fuel tank to the hard line on the framerail must be removed. If you are installing a fuel sump, you can skip steps 4-1 to 4-4. You will still need to remove the flex line per step 4-5.

4-1. The AirDog® II-5G DF-220 includes a 5/8" High Flow suction tube (P/N WAP109) to accommodate the high flows of this system. To install the WAP109 draw straw, you will need to remove the fuel tank from the truck. This step will be a lot easier with little to no fuel in the tank.

4-2. Disconnect the filler neck and tank vent line from the filler and vent hard lines by loosening the hose clamps.



Figure 1

4-3. Disconnect the connectors and wiring harness from the top of the tank.



Figure 2

## Section 4

## Removing the Fuel Tank and Lines

4-4. Once the fuel lines, filler and vent lines, and wiring has been disconnected from the tank, you can safely remove the fuel tank from the truck. A transmission jack will greatly improve the ease of disassembly.

### When Dropping the Tank, Always Remember, Safety First!



Figure 3



Figure 4



Figure 5

4-5. Once the fuel tank is removed, finish removing the factory flexible feed line from the truck by removing the end that is on the hard line right in front of where the fuel tank used to be. It will be the larger of the two lines. **Do not remove the smaller line as it is the engine return and will be hooked back up to the top of the tank once the installation is complete!!!** This line can be discarded as it will not be used. If you installed a sump, the factory connector at the top of the tank will need to be blocked off.



Figure 6



Figure 7

## Installing the WAP109 Draw Straw in the Fuel Tank

- 5-1. Once the tank has been dropped, remove the collection basket as shown in figures 8 and 9. A large flat head screwdriver and a mallet will aid in removing the module.



Figure 8



Figure 9

- 5-2. **DO NOT SKIP THIS STEP!!!** Now that the fuel module has been removed, you will need to modify it slightly to allow the AirDog Air/Vapor return to function properly once it is installed. You will need to cut the original suction line in the module to allow the return to flow back to the tank freely. It will be the larger of the two lines. If you accidentally cut the return line, that is fine. It won't affect the function of the installation. Once completed, set the module to the side to be reinstalled later.



Figure 10



## Section 5

## Installing the WAP109 Draw Straw

5-3. Select a spot to install the WAP109 draw straw. Be sure no bed supports or any cross members will contact the bulkhead fitting once the bed or tank is reinstalled. Drill a 1" hole using a step bit in your selected location (Figure 11). Hold a container below the drill point to catch debris as shown in figure 12.

**Figure 11****Figure 12**

5-4. Remove all burrs from the edge of the hole as shown in figure 13. Be sure to clean out any debris that may have dropped into the tank during the drilling process.

**Figure 13**

5-5. Install fitting 4A-1-02-10-08-S into the bulkhead fitting of the WAP109 draw straw, as shown in figure 14, using a 15/16 wrench. Tighten until the O-ring is no longer visible.

**Figure 14**

## Section 5

## Installing the WAP109 Draw Straw

5-6. Mock the suction tube in the fuel tank and measure from the top of the fuel tank to the bottom of the green seal (Figure 15). Take this measurement and add a 1/4 inch. Measure from the bottom of the tube and mark the previous measurement as shown (Figure 16). The added 1/4" will ensure the bottom of the straw is against the bottom of the tank once reinstalled.



Figure 15



Figure 16

5-7. Drill crossing pilot holes through the nylon tube, centered on the marked line, as shown (Figure 17). Use a larger bit (1/2" MAX) to open the holes up (Figure 18).



Figure 17



Figure 18

5-8. Cut the fuel tube to the measured length (Figure 19). Deburr the tube (Figure 20) to be sure no debris get pulled into the fuel pump.



Figure 19



Figure 20

5-9. Install the trimmed WAP109 into the previously drilled hole in the tank and orient it in the desired direction (Figure 21). Make sure the bottom of the straw is contacting the bottom of the fuel tank. Install the hardware in this order: washer, lock washer, nut. Tighten the nut with a 1.5" wrench or adjustable wrench till snug (Figure 23). **(Tank Cutaway is for reference. Access to straw is through module hole.)**



Figure 21



Figure 22



Figure 23

5-10. Re-install the fuel module. Re-install the factory return line **(The smaller of the two lines)** to the proper port of the fuel module before the tank is fully re-installed.



Figure 24

5-11. Reinstall the fuel tank in reverse order in which it was removed minus the original suction line that was removed in step 4-5.



Figure 25

## Installing the Supplied Fittings Into the AirDog II-5G Base

- 6-1. Dip the threaded end of the 08J2044-3/4UNF fitting into clean motor oil and hand-thread into the “ENGINE” port of the AirDog®II-5G filter base as illustrated in figures 26 and 27. Using a 7/8” deep socket, torque the fittings to 180in-lb or 15ft-lb. **DO NOT overtighten the fittings or damage may occur!**
- 6-2. Dip the threaded end of the 4A-1-02-10-08-S fitting into clean motor oil and hand-thread into the “INLET” port of the AirDog®II-5G filter base as illustrated in figures 27 and 28. Using a 15/16” wrench, snug the fitting until the O-ring is no longer visible. A torque spec is not given as a socket will not fit between the gerotor cap and the fitting. **DO NOT overtighten the fittings or damage may occur!**
- 6-3 Dip the threaded end of the 06J2044716UNF fitting into clean motor oil and hand-thread into the return port of the the AirDog®II-5G filter base as illustrated in figures 26 and 27. Using a 9/16” deep socket, torque the fitting to 84in-lb or 7ft-lb. **DO NOT overtighten the fittings or damage may occur!**

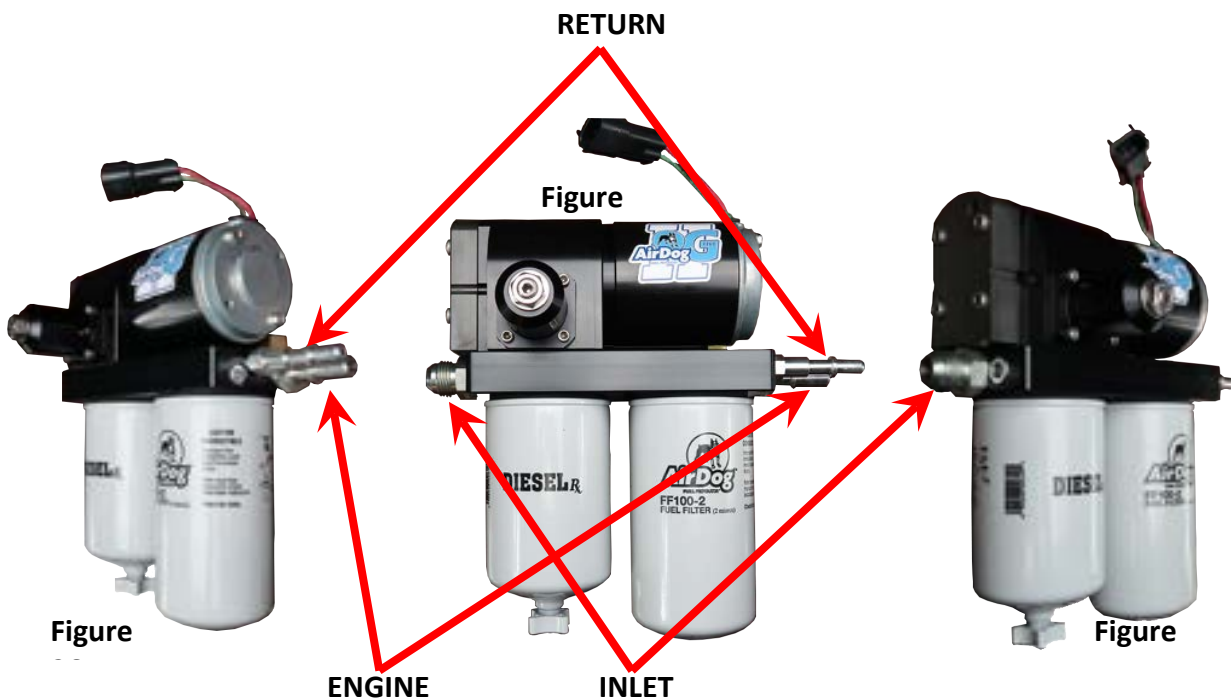



## Section 6

## Installing the Fittings and the Pump

6-4. Using the formed mounting bracket (part # 001-3C-0004), hold it up to the frame standoff and use it to mark where to drill the holes. Keep in mind to give plenty of clearance to keep fittings and fuel line away from the frame and the driveshaft. We aligned the bottom left hole with the left slot in the frame standoff.



Figure



Figure

6-5. Using a small drill bit as a pilot bit, drill the holes marked in step 6-4. Once those holes are drilled, step the bit up to a 5/16" bit and drill the holes. Be sure not to puncture the fuel tank when drilling.



Figure 31

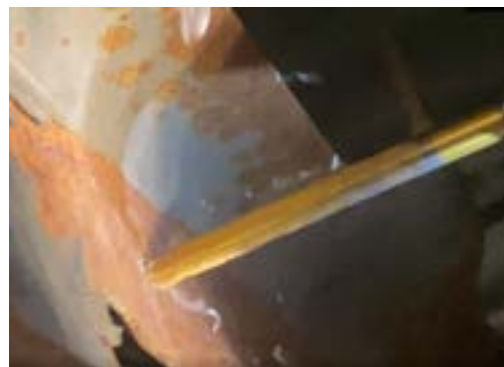

Figure 32

6-6. Using the supplied 1/4-20 bolts and hardware, mount the AirDog to the 001-3C-0004 bracket. You will be using a 3/16 allen wrench and a 7/16 socket. Take note on the orientation of the regulator as it is mounted to the basket. The pump will not fit in the truck if the regulator is facing the opposite way.



Figure 33



6-7. Once the pump is mounted to the bracket, use the 5/16-18 hardware to mount the pump and bracket to the frame standoff. You will need a 1/4" allen wrench and a 1/2" wrench. The regulator on the side of the pump will be facing towards the front of the truck when properly installed. **Note: Pump pictured is a DF-165. Your DF-220 pump will have a different inlet fitting. The mounting will be the same. Once complete, your pump should look like this on the standoff.**



Figure 34

## Assembling the Fuel Lines

**This kit includes a length of fuel line and separate fuel line ends to allow for much cleaner looking installations! Assemble the fuel lines as you install them. You won't want to pre-assemble the hoses or your lengths may be off.**

- 7-1. Take the fuel line end and lubricate the barbed end with clean motor oil (Figure 35) and press it into the fuel line (HS14) until all of the barbs are covered (Figures 36 and 37). The fuel line end should look like Figure 37.



**Figure 35**



**Figure 36**



**Figure 37**

- 7-2. Now plug that fuel line with that fitting into the connection on the either the AirDog or the truck where the manual calls it out.
- 7-3. Run the fuel line along the frame away from any hot or moving parts such as exhaust or the driveshaft (Figure 38). Cut the hose to length and insert the other fuel line end that the manual calls out into the fuel line as outlined in step 7-1.

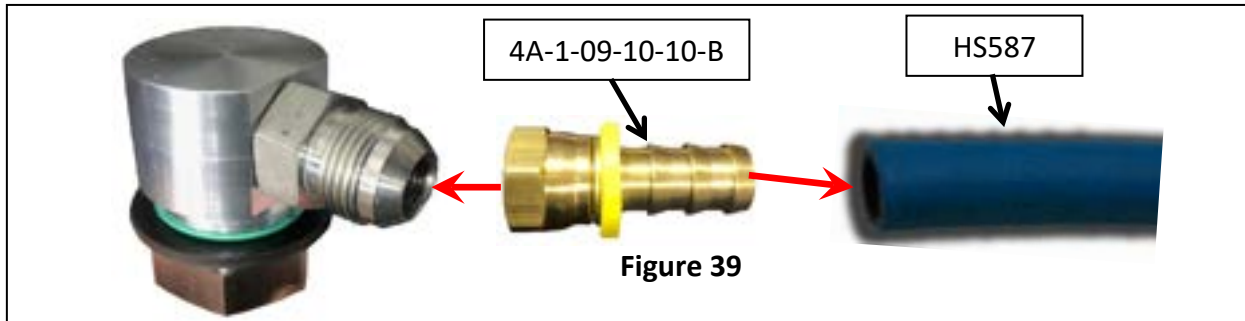

**Figure 38**

**NOTE: Hose clamps are not needed for these push-lock connectors and could damage the hose. These connections are rated for 300psi.**

## Fuel Suction Line for AirDog® II-5G DF-220

8-1. Assemble one end of the suction fuel line (reference section 7) using fuel line end 4A-1-09-10-10-B. Once the end is pressed in, connect it to the JIC fitting in the WAP109.® Use a 1” wrench to snug the fitting.



8-2. Run the fuel line along the frame as mentioned in step 7-3 to “Inlet” side of the AirDog. Cut the fuel line to length and insert fuel line end 4A-1-09-10-10-B per step 7-1. Once the fuel line end is pressed in, connect it to the 90° JIC fitting 4A-2-04-10-10-S. Connect the 90° fitting to the “inlet” fitting on the AirDog.

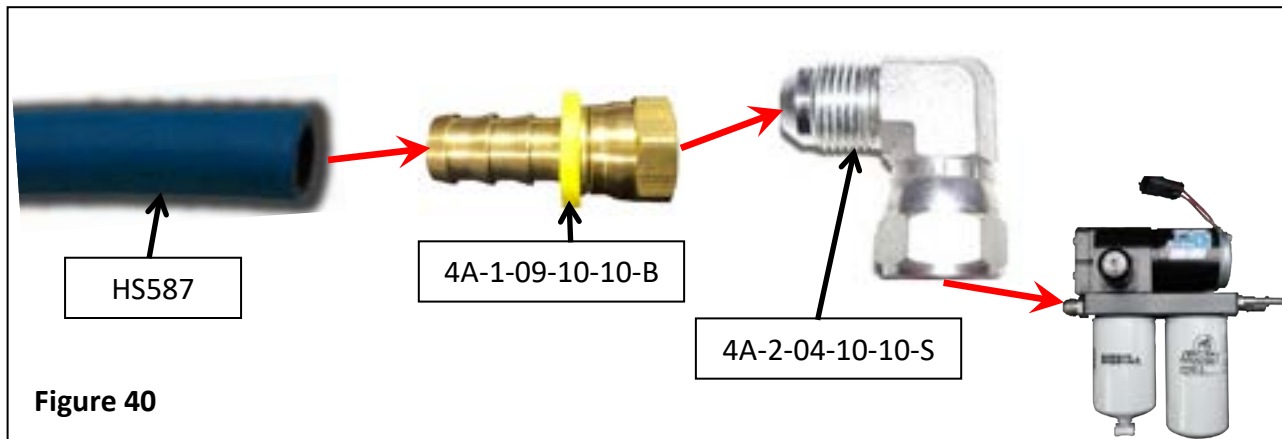

## Fuel Supply Line to Engine for AirDog® II-5G DF-220

9-1. Assemble one end of the hose (Reference section 7) using fuel line end FCQ1290 and plug it into the J2044 male connection on the factory fuel line to where the factory suction line was just removed from behind the fuel cooler in the previous step. A “click” will be heard once properly connected.

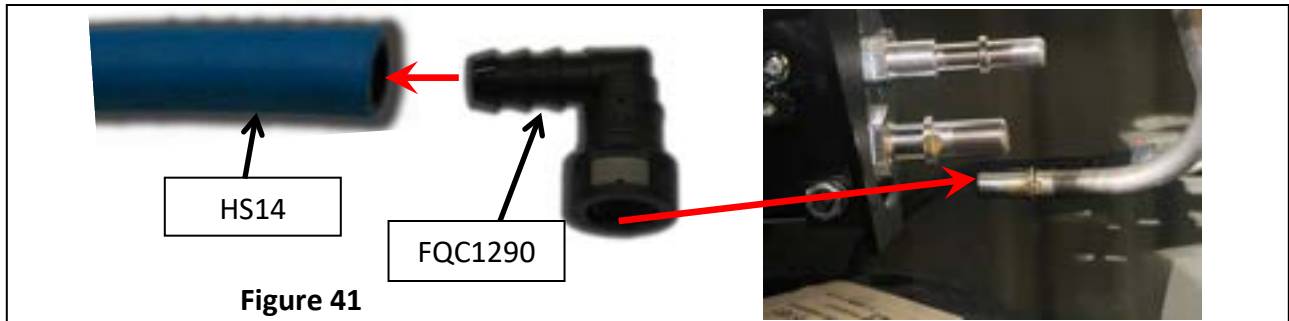

9-2. Run the fuel line along the frame as mentioned in step 7-3 to the “Engine” port in the AirDog®. Cut the fuel line to length and insert fuel line end FQC12S per step 7-1. Once the connector is installed, connect it to the male J2044 fitting in the “Engine” port in the AirDog®. A “click” will be heard once properly connected.

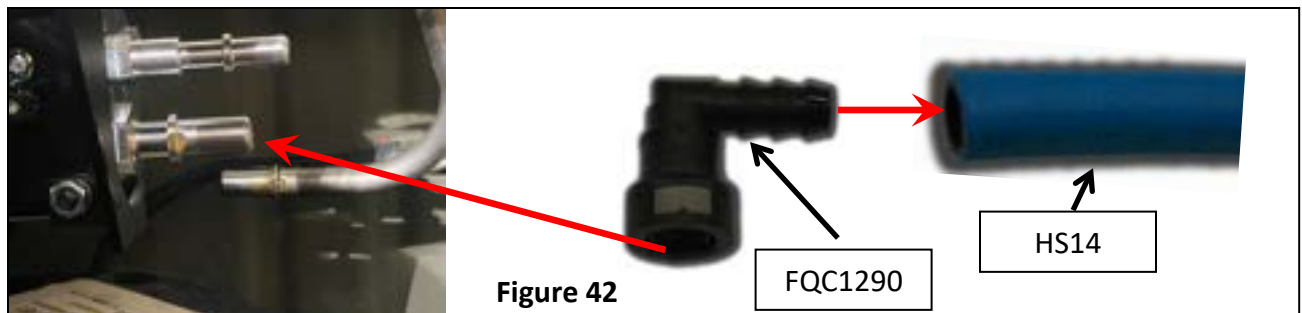

**CAUTION:** Properly secure all fuel lines to prevent damage from chaffing and/or abrasion.

## AirDog® II Fuel Return Line

10-1. Assemble one end of the hose (Reference section 7) using Fuel line end FQC3890 and plug it into the “Return” J2044 fitting installed in the AirDog® (Figure 43). A “click” will be heard once the fitting is properly connected.

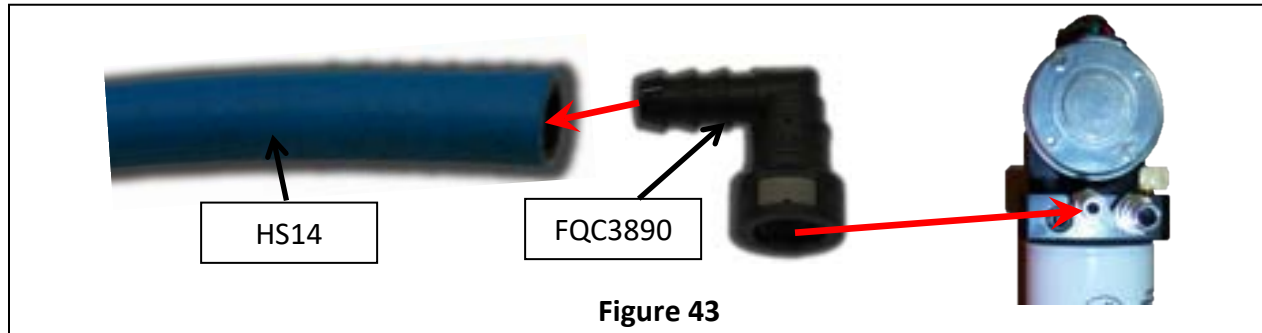

10-2. Run the fuel line along the frame as mentioned in step 7-3 to the factory J2044 male 11.8mm return quick connect fitting on top of the tank. Cut the fuel line to length and insert fuel line end **FQC118S** per step 7-1. **Note: The FQC118S fitting will have a RED DOT on the fitting.** Once the connector is installed, connect it to the male J2044 fitting in the **factory outlet/suction line in the fuel module**. It will be the larger of the two fittings. The factory engine return should have been reconnected when the module was reinstalled. The factory return from the engine must be reconnected to its factory location. A “click” will be heard once properly connected.

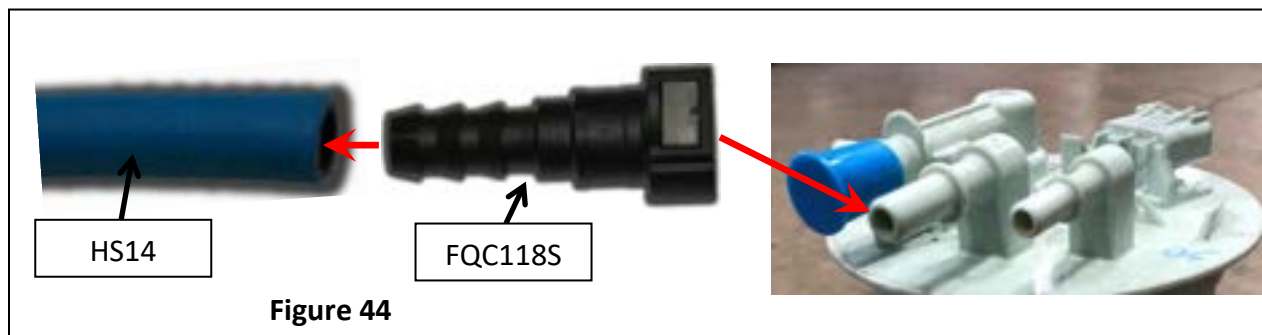

## AirDog® Wiring Harness Install

### WIRING DIAGRAM

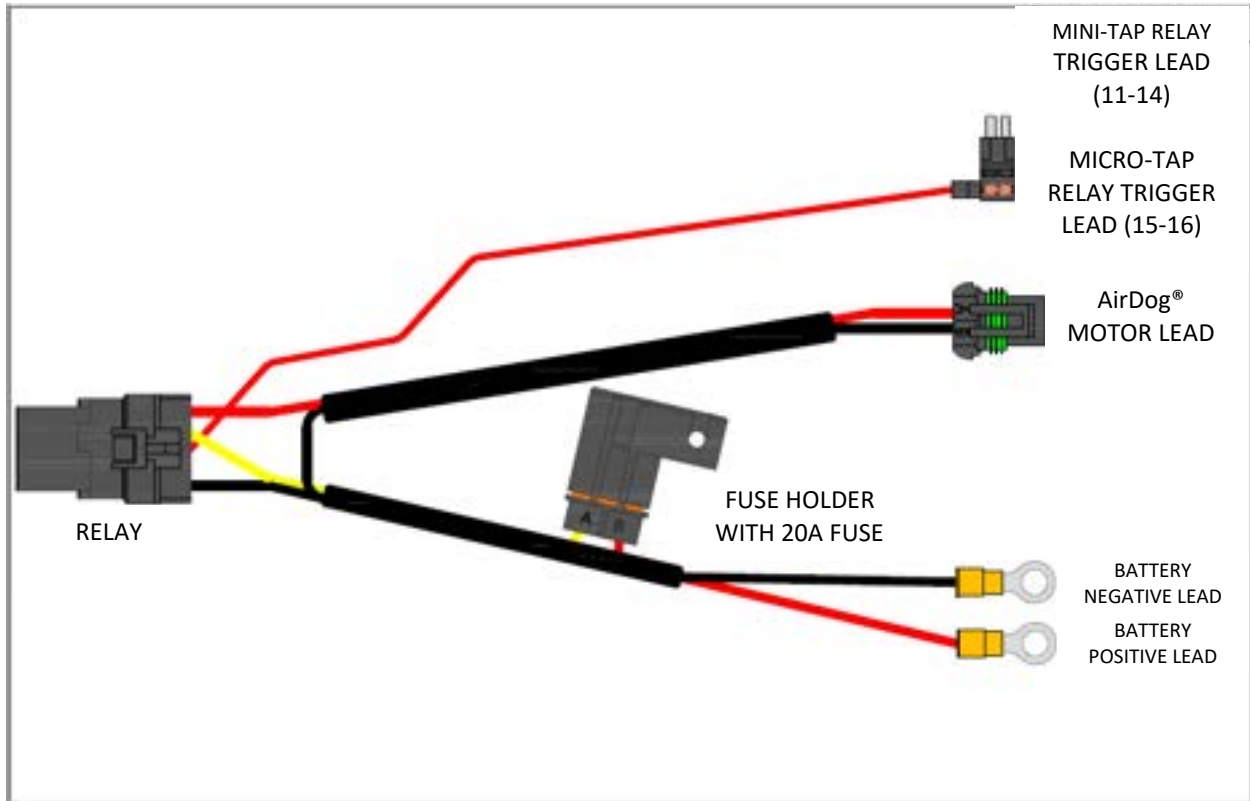

Figure 45

### Secure the Relay and Fuse Holder to the Vehicle

11-1. Secure the relay and fuse holder to the vehicle. Be sure to route the wires away from any moving parts. The relay is illustrated below in figure 46. The fuse holder mounting is the same concept.



Figure 46



### Connecting the AirDog® Relay Control

11-2. Remove the under hood fuse box cover. On some models it may be necessary to remove the fender/cowl brace to allow access to the fuse box

11-3. After accessing the fuse panel, use a test light or voltmeter to find a fuse terminal that is **HOT** only when the ignition is in the “on” position. Connect the ‘Red’ Relay Trigger wire with the mini fuse tap to that terminal. Be sure to install the fuse that is removed back into the fuse tap we supply, once installed into the fuse box the fuse tap should have both fuse spots filled. **TBC Batt, Ign 1 or 2, Acc and HVAC are commonly used to supply power.**



Figure 47

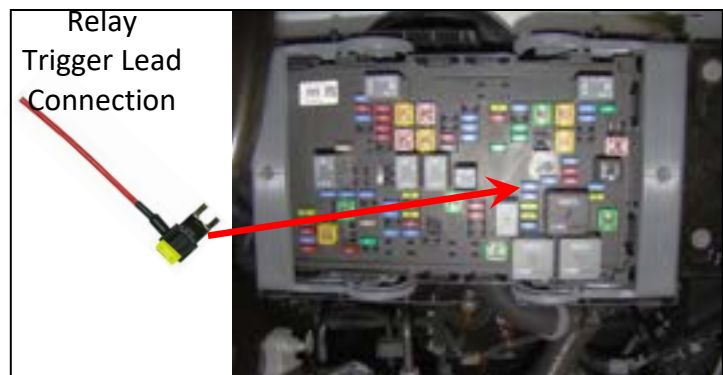

Figure 48

### Connecting the Power Supply Leads to the Alternator or Battery

**Note:** Connecting the power supply leads to the alternator instead of the battery will create a corrosion resistant connection.

11-3A. Route the Red and Black power supply leads to the alternator. Connect the Black (-) lead to the alternator Chassis Ground connection. Connect the Red (+) lead to the alternator Hot Lead going to the battery.

Black (-)

Red (+)

Replace the Protective Cover



Figure 49



Figure 50

## Connecting the power supply leads Continued

11-3B. Should you choose to connect the power supply leads directly to the battery, connect the Red (+) led to the Positive (+) post of the driver's side battery. Connect the Black (-) lead to the Negative (-) post of the same battery.

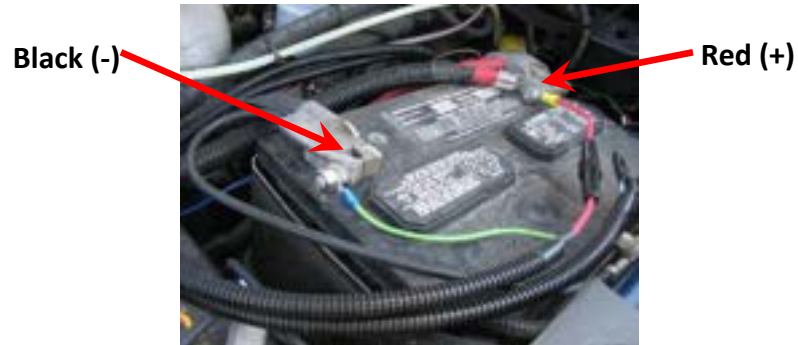

Figure 51

11-4. Route the wiring harness to the AirDog® and connect the 2 pin Metri-Pack connector to the corresponding connector on the AirDog®.



Figure 52



## INITIAL START PROCEDURE

- 12-1. The AirDog®II-5G is a self-priming system, however, to prevent possible damage to the system, it is recommended to fill the water separator with clean diesel fuel before initial startup.
- 12-2. Rub clean diesel fuel or oil on the filter seals before installing to ensure a proper seal.
- 12-3. Turn the starter key to the on/run position.
- 12-4. If the pump struggles to prime, loosen the fuel filter as the pump is running. As soon as fuel starts spraying out, tighten the filter as quickly as possible. Be sure to wear safety glasses! **NOTE: put a rag or shop towel over and around the filter to prevent splatter. Catch all spilled fuel and dispose of properly. Wear safety glasses!**
- 12-5. Start engine.

**RECHECK ALL FUEL FITTINGS FOR LEAKAGE AND BE SURE THEY ARE PROPERLY TORQUED. BE SURE ALL FUEL LINES ARE PROPERLY ROUTED TO PROTECT FROM EXCESSIVE HEAT AND SECURED TO PROTECT FROM CHAFFING AND ABRASION. RECHECK ALL ELECTRICAL LINES, SECURE AS NECESSARY.**

### CHECKING FOR EXCESSIVE PUMP NOISE

**NOTE: Each AirDog®II has been manufactured in a Quality Controlled process and wet tested for operation and performance before shipment. This is a smooth running system. With fuel or air alone, the AirDog®II fuel pump will run quietly. However, if any fuel fitting on the vacuum side, between the fuel tank and the AirDog®II or the pre-filter has been left loose during the installation process, the system may be sucking air at an excessive rate and will be very noisy. Excessive restriction in the suction line from the fuel tank can cause vapor and noise, as well. To check for these problems, unscrew the pre-filter 3 or 4 full turns and activate the AirDog®II by turning the ignition switch to on. If the AirDog®II runs quietly, then excessive air from a loose fitting or leaking pre-filter seal or vapor from fuel flow restriction is most likely the reason for the excessive noise. Correct as necessary.**

- A. The seal groove in the 3" filter is a snug fit and on occasion the seal has been found to not be fully seated. Remove the pre-filter, remove the seal from the top of the nut plate. Clean and lubricate the seal groove. Carefully replace the seal in the groove. Be sure to fully seat the seal.
- B. Check all fittings, especially the quick connect at the tank.

## FILTER SERVICE RECOMMENDATIONS

Plugging of either the fuel filter or the water separator itself will cause low fuel pressure and low flow to the engine. If a low fuel pressure issue exists, replace the fuel filter. Typical fuel filter life is 15-20k miles depending on fuel quality.

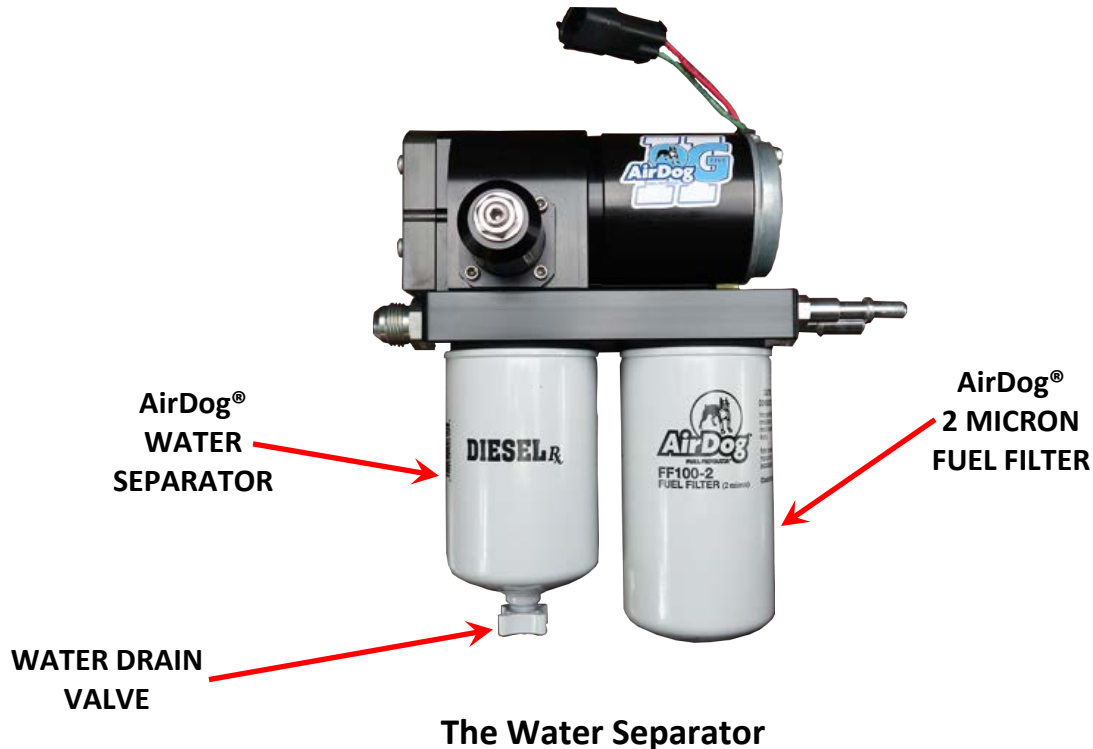

Replace the water separator every other time you change the Fuel Filter or if it becomes damaged or plugged. It is suggested to check/drain the water separator every three months or as needed should you experience excessive 'water in fuel' conditions. When installing the water separator, be sure to clean the underside of the AirDog® base. Follow the instructions printed on the pre-filter for proper tightening procedures.

**CAUTION:** Be extremely careful to prevent any contaminants or debris from entering the pre-filter when removing it for cleaning! Large debris will jam the Gerotor and cause the fuse to blow. This is not a warranty item. Should this happen, you can easily put the system back into working order. See the instructions on "How to clean the Gerotor" for proper procedures.

### The Fuel Filter

Remove the fuel filter by turning it counter clockwise. **DO NOT** pre-fill the fuel filter with fuel. The AirDog® will fill the filter and prime the system automatically. Follow the instructions on the filter for proper tightening procedures.

**CAUTION:** Dispose of waste fuel and used filters properly

**CLEANING DEBRIS/CHECKING FOR DAMAGE IN/TO THE GEROTOR ASSEMBLY**

**STEP 1:** Remove the four (4) socket head cap screws that secure the Gerotor cap using a 3/16 allen wrench.

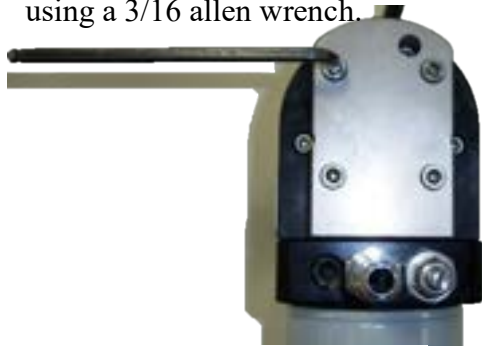

**STEP 2:** Carefully remove the O-rings you will need to reuse them.



**STEP 3:** Remove and clean the Gerotor. Be very careful to not damage the Gerotor.

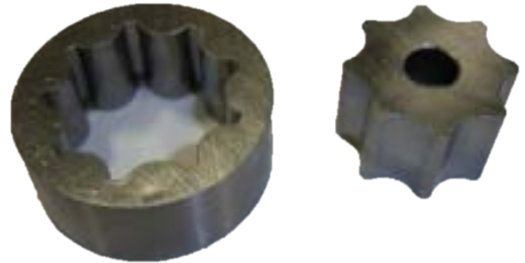

**STEP 4:** Remove the O-rings and clean/inspect the inside of the Gerotor pocket.

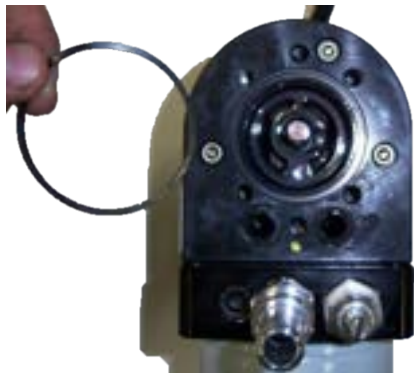

**STEP 5:** Reinstall the center gear.



**STEP 6:** Align and install the outer gear and O-rings.



**STEP 7:** Install the Gerotor Cap. Be very careful not to dislodge or pinch the O-rings.



**STEP 8:** Loose assemble the cap screws. Torque the cap screws in an opposing pattern.

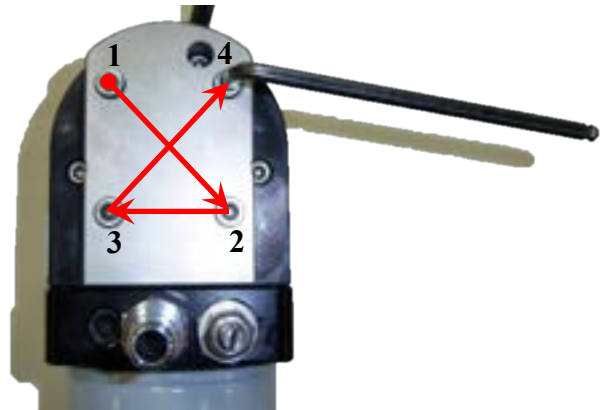

If there is damaged found to either the Gerotor, Gerotor pocket, or O-rings, call into AirDog® Tech Support for further assistance.

### AirDog®II-5G ADJUSTABLE FUEL PRESSURE REGULATOR

The AirDog®II-5G rises to a new level of performance with an adjustable diaphragm fuel pressure regulator. This regulator offers more consistent fuel pressure and allows for higher flow rates at pressure. This regulator can also be boost compensated to battle any pressure drops under wide open throttle. The boost compensation kit is sold separately.

#### PRESSURE ADJUSTMENT FOR THE DURAMAX

Loosen the Jam Nut with a 5/8 wrench  
Re-torque after adjustment

Use a 3/16 allen to adjust the pressure  
regulator



#### PRESSURE ADJUSTMENT

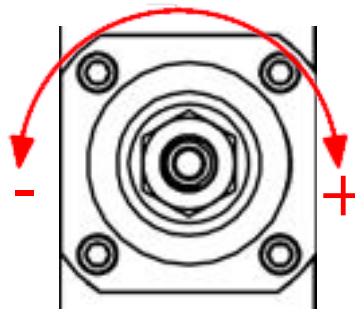

**PRE-SET AT 8-10PSI  
FROM FACTORY**

Turn the adjuster screw counter-clockwise to reduce the output pressure or clockwise to increase the pressure. Be sure to re-torque the jam nut after adjusting the regulator. **IT IS STRONGLY RECOMMENDED TO ADJUST THE PRESSURE WHILE USING A FUEL PRESSURE GAUGE. TOO MUCH OR TOO LITTLE PRESSURE MAY CAUSE DAMAGE TO THE INJECTION SYSTEM!**

Every AirDog II-5G has a 90-degree brass fitting in the pump to where you can add a fuel pressure gauge or fuel pressure sending unit for an electric gauge.



## Installing a New Filter

1. Clean the area around the filter head and groove or seal area.
2. Install a new fuel filter on the filter head. Turn clock-wise until the filter contacts the seal. Tighten the filter one full turn or follow tightening instructions on filter after contact with the seal has been made.

**NOTE:** It is not necessary to pre-fill the fuel filter!

**CAUTION:** DO NOT OVER TIGHTEN, OVER TIGHTENING CAN DISTORT THREADS OR DAMAGE THE FILTER SEAL.

3. **To prime the filter**, turn the ignition switch to the on position. Start the engine.

## Water Separator

With the engine turned off, pinch off the suction line. Open valve on the bottom of the water separator. Drain into a suitable container until all water has been removed. Close valve. Remove the pinch in the suction.

**DRAINING:** The water separator should be serviced once a month or when severe water in fuel conditions require.

**NOTE:** Collect all spilled fuel and dispose of in accordance with federal, state and local regulations.

**PUREFLOW AIRDOG**  
***LIFETIME LIMITED EXPRESS WARRANTY***  
 FOR  
 Covered PureFlow AirDog I, II and Raptor Systems

**IMPORTANT NOTICE**

**TO ACTIVATE YOUR PUREFLOW AIRDOG WARRANTY, YOU MUST COMPLETE AND MAIL YOUR WARRANTY CARD TO PUREFLOW AIRDOG WITH A COPY OF YOUR ORIGINAL SALES RECEIPT WITHIN 30 DAYS OF PURCHASE. FAILURE TO COMPLETE AND SUBMIT YOUR WARRANTY CARD WILL RESULT IN A WARRANTY PERIOD OF THE COVERED PRODUCT TO ONE (1) YEAR FROM THE DATE OF PURCHASE.**

PureFlow AirDog (hereafter collectively, "SELLER") warrants and guarantees only to the Original Purchaser (hereafter collectively, BUYER) that All PureFlow AirDog Systems systems FP-100, FP-150, DF-100, DF-165, DF-220, Raptor Fuel Pump RP-100-4G or RP-150-4G, FRRP-100 or FRRP-150 (hereafter collectively, PRODUCT) shall be free from defects of materials and workmanship in the manufacturing process for as long as the BUYER owns the PRODUCT.

The Lifetime Limited Express Warranty is limited to the PRODUCT purchased by the original BUYER of the PRODUCT and limited solely to the parts contained within the PRODUCT and EXCLUDES ALL ELSE INCLUDING FILTERS AND WATER SEPARATORS. Any PRODUCT that is in question of Warranty must be returned, shipped prepaid, to PureFlow AirDog. All Warranty claims are subject to the approval of PureFlow AirDog. If it is determined that a Warranty claim exists, PureFlow AirDog will, at its sole discretion, replace the defective PRODUCT with a comparable PRODUCT, repair the defective PRODUCT, or refund the BUYER'S purchase price in exchange for the PRODUCT. Repairs or replacements are warranted for only the remainder of the original warranty period and only to the original BUYER.

Under no circumstances shall the SELLER be liable for any labor charged or travel time incurred in the diagnosis for defects, removal, or reinstallation of the PRODUCT, or any contingent expense.

Under no circumstances will the SELLER be liable for any damage or expense incurred by reason of the use or sale of the PRODUCT.

Other than expressly set forth herein, the SELLER shall in no way be responsible for the proper or improper use and service of the PRODUCT. In no event shall the SELLER be liable for any special, incidental, indirect or consequential damages of any kind or nature, whether or not the BUYER of the PRODUCT was advised of the possibility of damage or harm, arising or resulting from the use or performance of the PRODUCT and BUYER hereby waives the right to any and all such claims.

BUYER, acknowledges that he/she is not relying on SELLER'S skill or judgment to select or furnish goods suitable for any particular purpose and that SELLER has no liability that will extend beyond the scope of the LIMITED EXPRESS WARRANTY contained herein, and BUYER hereby waives all remedies or liabilities, expressed or implied, arising by operation of law or otherwise.(including, without limitation, any obligation of SELLER with respect to fitness for any particular purpose; merchantability; and special, incidental, indirect or consequential damages) or whether or not occasioned by SELLER'S negligence.

SELLER disclaims any warranty and expressly disclaims any liability for personal inquiry or damages related to BUYER'S use of the PRODUCT. BUYER acknowledges and agrees that the disclaimer of any liability for personal injury is a material term for this agreement and BUYER agrees to indemnify SELLER and hold SELLER harmless from any claim related to the PRODUCT and its use or performance. Under no circumstances will SELLER be liable for any damages, liabilities, costs or expenses incurred as a result of or by reason of use, performance or sale of the PRODUCT, including without limitation, any damages, liabilities, costs or expenses incurred by reason of BUYER'S negligence related to those uses of the PRODUCT.

The proper installation of the PRODUCT is the sole responsibility of the BUYER. The SELLER assumes no liability regarding improper installation or misapplication of the PRODUCT.

SELLER hereby provides the following limited warranty as to description, quality, merchantability, fitness for the PRODUCT'S purpose, productiveness, or any other matter of SELLER'S PRODUCT sold herewith. The SELLER shall be in no way responsible for the open use and service of the PRODUCT and the BUYER hereby waives all rights other than those expressly written herein. This Warranty shall not be extended or varied except by a written instrument signed by SELLER and BUYER.



IN THE EVENT THAT THE BUYER DOES NOT AGREE WITH THIS AGREEMENT, THE BUYER MAY PROMPTLY RETURN THE PRODUCT, IN A NEW AND UNUSED CONDITION, WITH A DATED PROOF OF PURCHASE, TO THE PLACE OF PURCHASE WITHIN THIRTY (30) DAYS FROM THE DATE OF PURCHASE FOR A FULL REFUND. THE BUYER AGREES THAT THE INSTALLATION OF THIS PRODUCT CONFIRMS THE BUYER HAS READ AND UNDERSTANDS THIS AGREEMENT AND ACCEPTS THE TERMS AND CONDITIONS OF THIS AGREEMENT.

## Warranty Procedure

In the unlikely event a warranty appears as if it may be warranted, the following steps are taken:

- 1 The customer discussed the symptoms of the problem with a PureFlow AirDog Technician. The customer is to have the system Serial Number and Model Number available for the Technician when the call is made. This will expedite all steps of the process.
- 2 The customer performs any and all tests requested by the PureFlow AirDog Technician. This is done to isolate the potential problem while eliminating potential installation or maintenance related issues,
- 3 If the PureFlow AirDog Technician determines based on the customer feedback concerning the requested testing that system may be at fault, the customer is advised that all returned pumps are tested upon arrival and should this returned pump perform at design criteria upon arrival, the customer will be charged a \$50.00 fee.
- 4 The PureFlow AirDog Technician will first request the customer's phone number in the event the phone call is accidentally disconnected and then transfer the customer to a PureFlow AirDog Customer Service Representative. Should a Customer Service Representative not be available, the Technician will offer the Customer the option to hold, call back, or receive a return call.
- 5 The PureFlow AirDog Customer Service Representative will check to determine if the customer's Warranty Registration Card is on file.
  - a. If no Warranty Registration is found, the customer will be required to supply the original purchase receipt showing the purchase date.
  - b. If no Warranty Registration is found, the customer will be advised of the options should the system in question is out of the default warranty period (1 year).
- 6 The PureFlow AirDog Customer Service Representative will request the customer information, including: Name, Address, Phone Number, Model Number, Serial Number, Year / Make / Model of vehicle, Name of Dealer purchased from, Purchase Date, Description of Problem, Customers' understanding of the resolution, and customer credit card information.
- 7 PureFlow AirDog will cover Ground Shipping charges to ship the replacement unit and will include a prepaid shipping label for the return of the defective unit. Any additional items ordered at the time of the replacement shipment will include their portion of the shipping cost.
- 8 A period of 15 Calendar Days from the time of shipment is provided for the receipt of the defective unit at the PureFlow AirDog facility. Failure to return ship the defective unit to arrive within the defined time period will result in a charge of \$250.00 against the customer's credit card as the purchase cost of the defective unit.