







LOW FUEL PRESSURE INDICATOR LIGHT INSTALLATION MANUAL

COMPONENTS INCLUDED IN THE KIT

QTY	DESCRIPTION	PART NUMBER	IMAGE
1	NAMEPLATE	250-3-0003	
1	PRESSURE SWITCH	5C-9-007	
1	LIGHT	5G-1-1-0004	
1	ELBOW FITTING*	4A-5-02-02S	
1	GROMMET	5J-1-1-04-2758	
1	WIRING HARNESS	5E-2-IND	
1	TRIGGER WIRE TAP	31572	

***THIS FITTING IS NOT USED FOR THE AIRDOG II-4G**

INSTALLING THE PRESSURE SWITCH TO THE AirDog® OR AirDog®II BASE

1. Remove the 1/8 NPT pipe plug from the top of the base using a 3/16 allen wrench.



2. Install the 45° elbow (4A-5-02-02S) in the port. Be sure face it away from the motor. **DO NOT OVERTIGHTEN.**

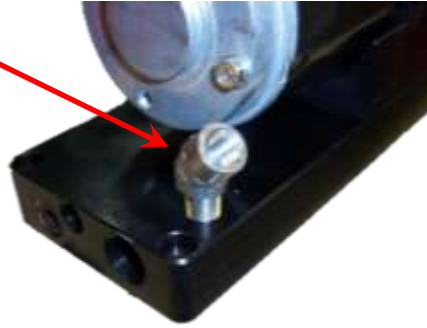

3. Install the pressure switch (5C-9-007) into the 45° elbow fitting (4A-5-02-02S) as shown below. **DO NOT OVERTIGHTEN.**



NOTE: IF THIS KIT IS BEING USED FOR AN AirDog® II-4G, REMOVE THE PIPE PLUG FROM THE 90° FITTING ALREADY INSTALLED ON THE PUMP AND INSTALL THE PRESSURE SWITCH IN THAT FITTING. THE 45° FITTING IS NOT USED.

INSTALLING THE INDICATOR LIGHT NAMEPLATE

1. Pick a suitable location on the dash/kick panel to mount the indicator light where the indicator leads can be easily routed and drill a 1/2" hole.
2. Remove the protective layer on the nameplate (250-3-0003) and install it over the drilled hole.



INSTALLING THE WIRING HARNESS AND LIGHT

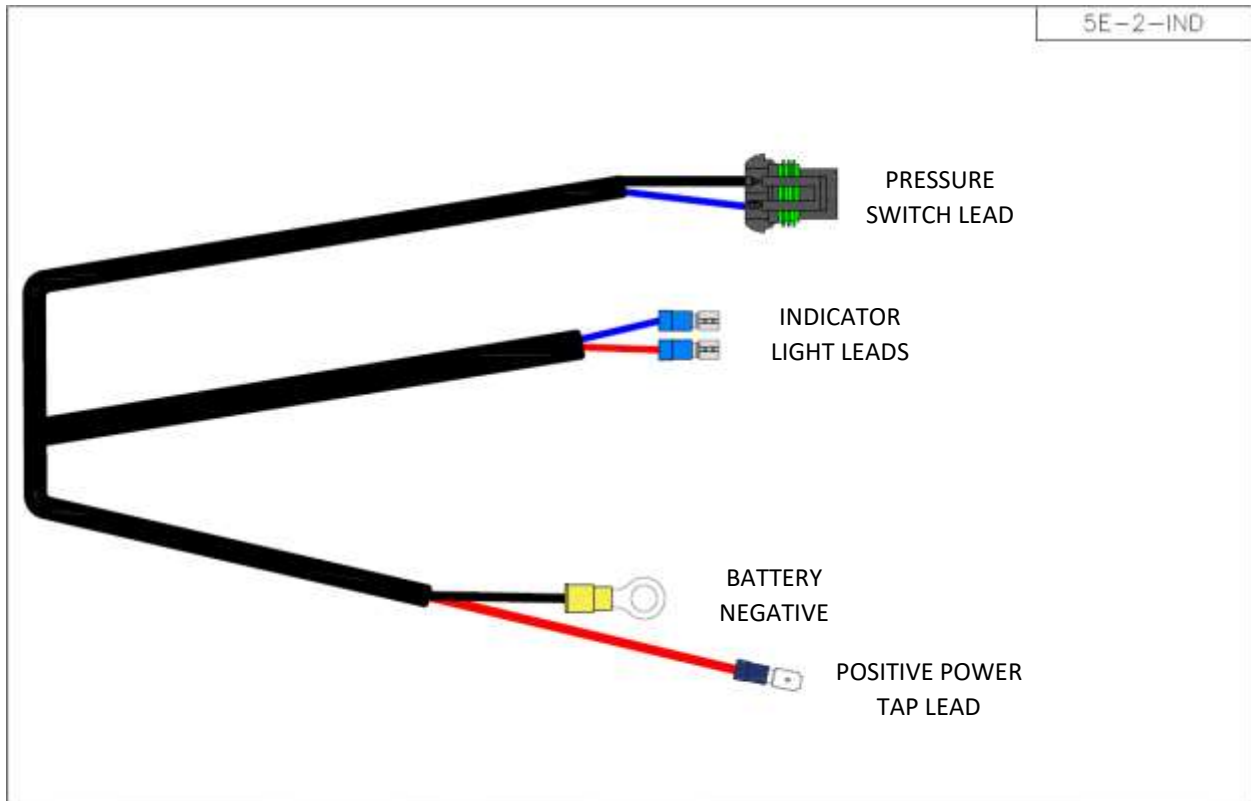

1. Plug the pressure switch lead from the harness into the pressure switch installed on the AirDog® base.



2. Run the wiring harness along the frame rail away from any moving or hot parts and connect the ground lead to the battery terminal. Use the supplied cable ties to secure the harness.

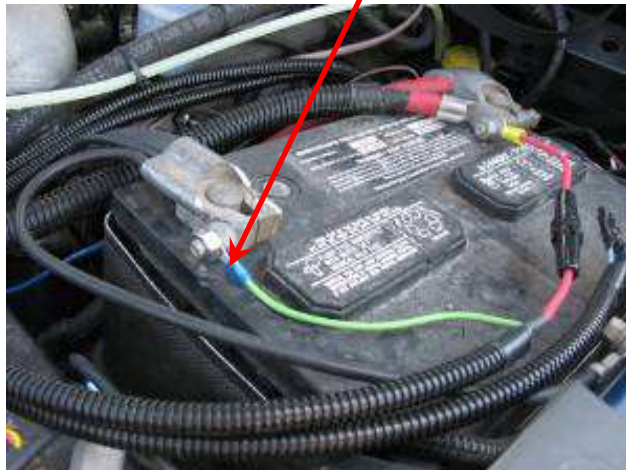

3. Find a key on hot wire to install the wire tap onto. A good source is the cigarette lighter port positive wire.



4. Next, run the positive power tap lead and the indicator light leads through the firewall using an existing wire pass through or use the supplied grommet and make a new pass through. The grommet installs in a 5/8" hole.

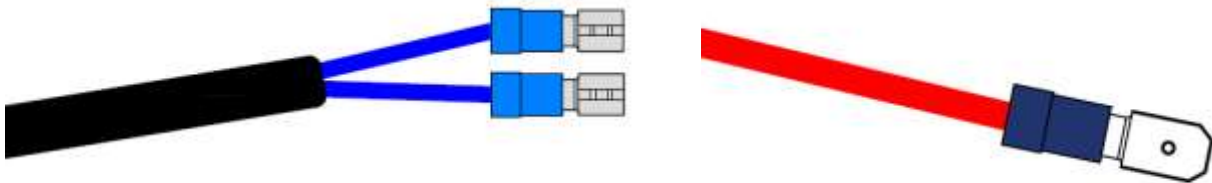

5. Pull the indicator leads through the freshly drilled hole.
6. Install the leads on the indicator light. **IT DOES NOT MATTER WHAT SIDE THE LEADS ARE CONNECTED TO ON THE LIGHT.**

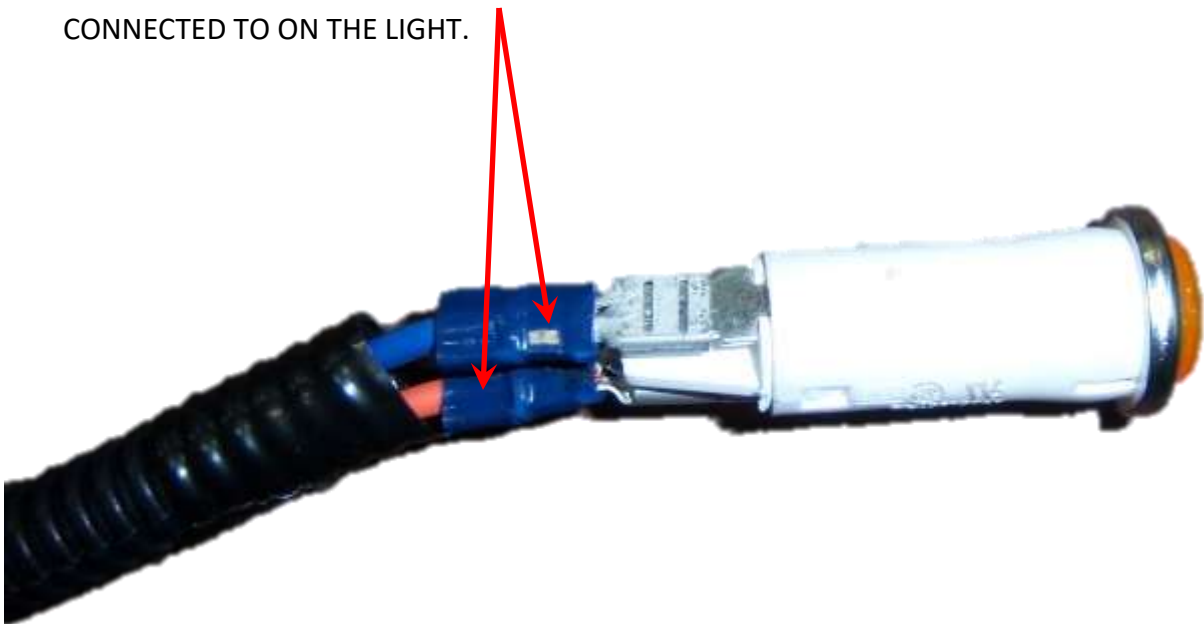

7. Push the indicator light into the drilled hole until it snaps in place.



8. Next, run the tap wire to the tap that was previously installed in step 3 and plug it in.

FINISHING PROCEDURES

1. Route excess wiring out of the way of any pedals or moving parts. Secure with zip ties.
2. Bump the starter to put the AirDog® in a 30sec run time and check for any leaks at the 45° fitting.
3. Replace the filter when the light stays on **ONLY!**