

HD
MOMENTUM™

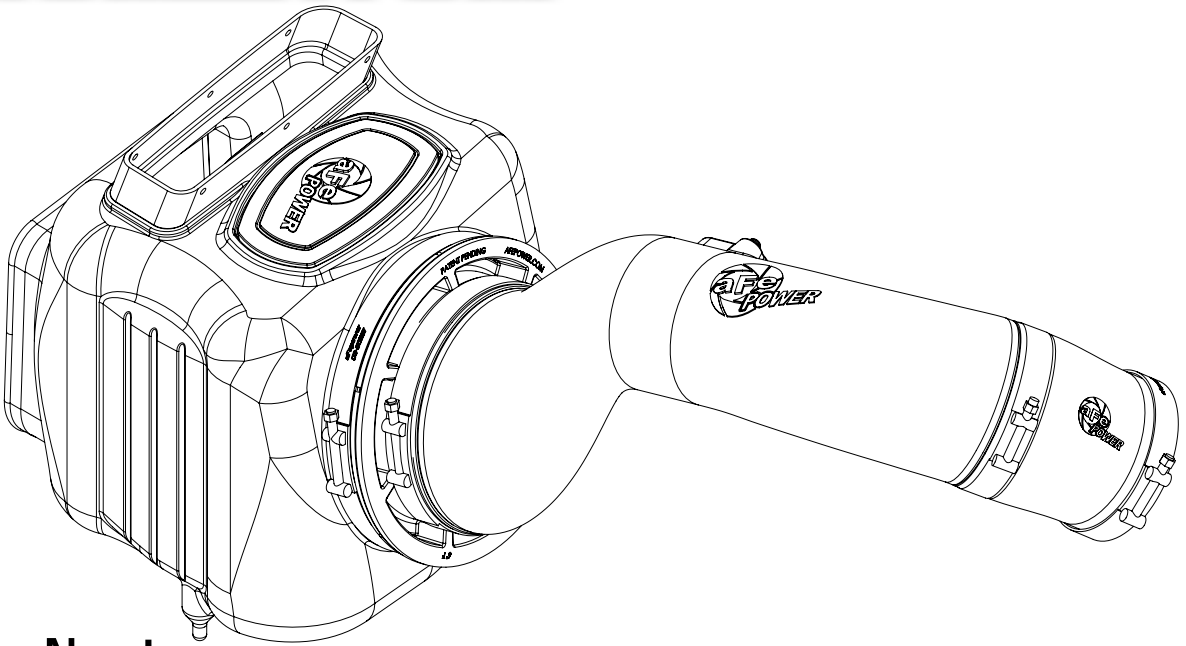

The Next
Generation
of Intakes
advanced FLOW engineering

Instruction Manual P/N: 50-74008 / 51-74008

Make: **Chevrolet** Model: **Silverado HD**

Year: **2017-2019** Engine: **V8-6.6L Duramax (L5P)**

Make: **GMC** Model: **Sierra HD**

Year: **2017-2019** Engine: **V8-6.6L Duramax (L5P)**

Note: **Includes Denali Models.**



- Please read the entire instruction manual before proceeding.
- Ensure all components listed are present.
- If you are missing any of the components, call customer support at 951-493-7100.
- Ensure you have all necessary tools before proceeding.
- Do not attempt to work on your vehicle when the engine is hot.
- Disconnect the negative battery terminal before proceeding.
- Retain factory parts for future use.

Label	Qty.	Description	Part Number
A1	1	Pro DRY S Air Filter	21-91059
A2	1	Pro 10R Air Filter	20-91059
B	1	Tube	05-74008B1
C	1	Housing	05-74008B2
D	1	Scoop	05-74008B3
E	1	Clamp, T-bolt (8-5/16" - 8-5/8")	03-50267
F	1	Coupling, Silicone Elbow	05-01420
G	1	Clamp, T-bolt (4-5/16" - 4-5/8")	03-50499
H	1	Seal Trim 7/16" (27" Inches)	05-00072
I	2	Screws, Torx M4	03-50491
J	1	Clamp, T-bolt (4-1/16" - 4-3/8")	03-50262

Installation will require the following tools:

8mm Nut driver, 11mm Nut driver, T20 torx bit or driver, 13mm deep socket, extension and driver.

Note: Legal in California for use on race vehicles only. The use of this device on vehicles used on public streets or highways is strictly prohibited in California and others states that have adopted California emission regulations.

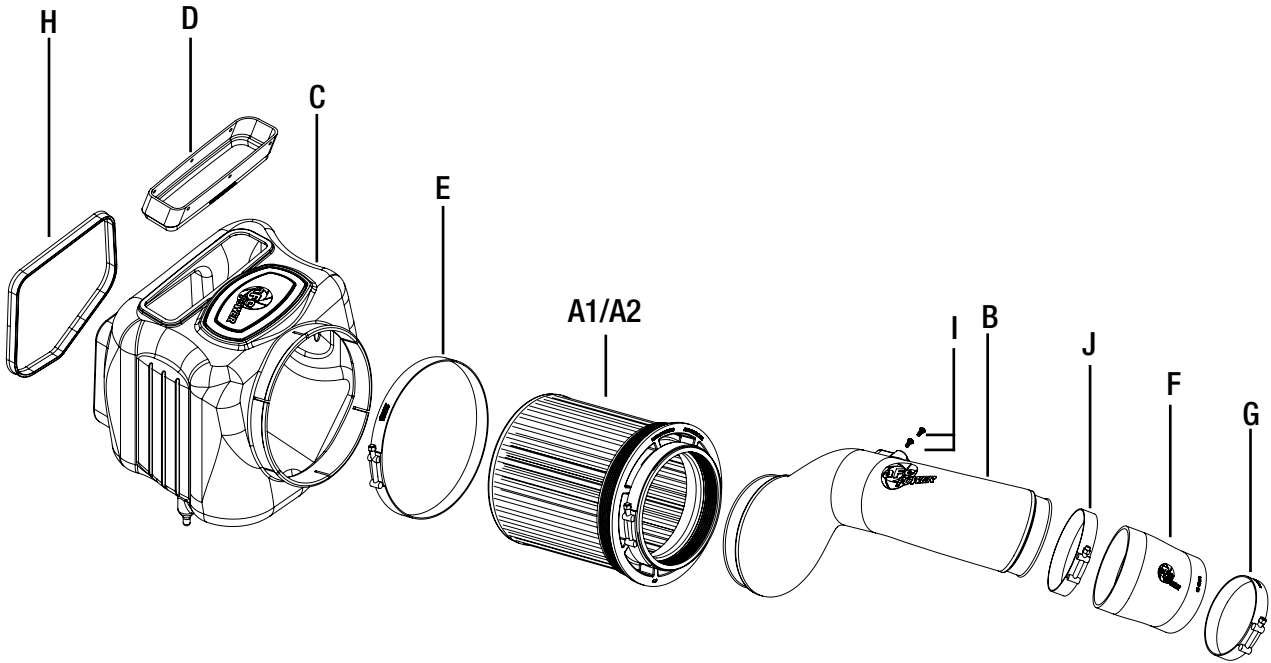



Refer to Figure A for Steps 1-2

Step 1: Disconnect the MAF sensor plug. ①

Step 2: Disconnect the MAF sensor harness clip ② from the OE airbox.

**Figure B****Refer to Figure B for Steps 3-4**

Step 3: Loosen the clamps (3) at the airbox and at the resonator coupler.

Step 4: Remove the stock intake tube. (4)

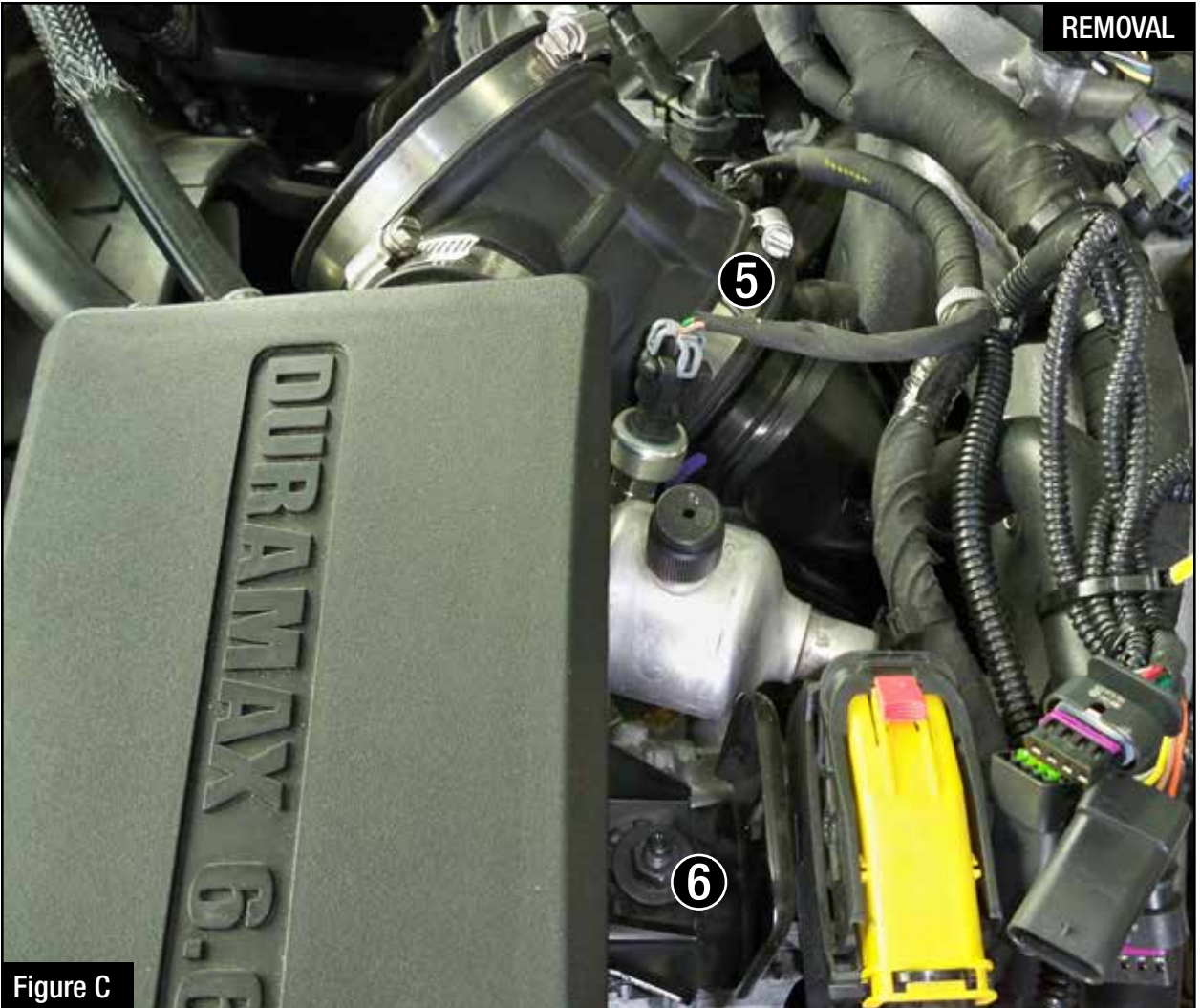
Figure C
Refer to Figure C for Step 5

Step 5: If you wish to remove the resonator, loosen the clamp (5) at the turbo inlet with an 8mm nut driver. Using a 13mm deep socket, extension and driver, remove the nut (6) holding the resonator. Remove the resonator with the stock coupler.

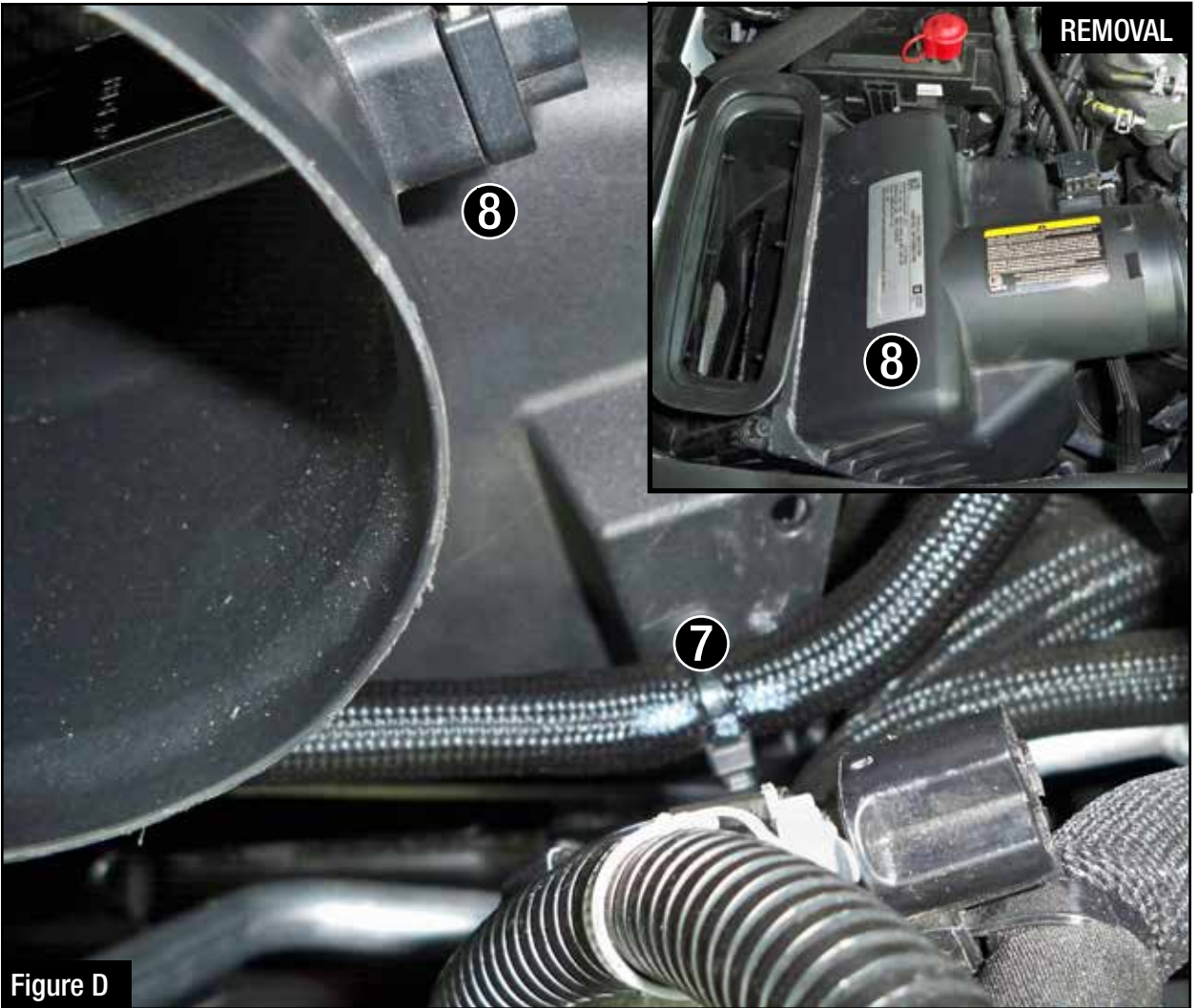
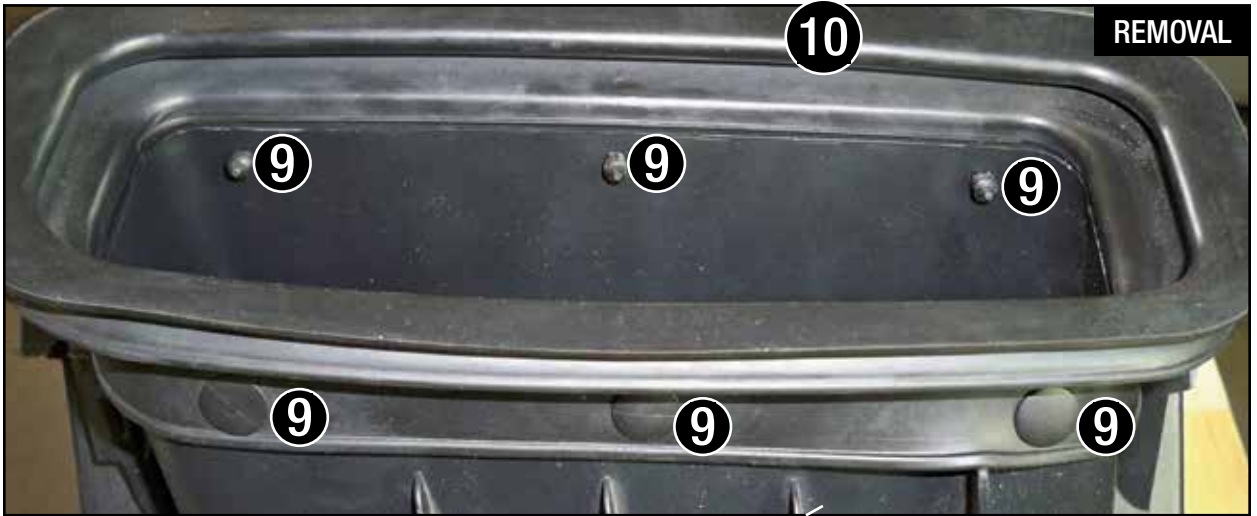

Figure D

Refer to Figure D for Step 6

Step 6: Remove the coolant line clip (7) from the airbox then remove the factory airbox (8) out of the vehicle. (Use an upward pull to release the retaining plug).



Refer to Figure E for Step 7

Step 7: Remove the 6 clips (9) holding the rubber seal (10) on the stock airbox. Remove the rubber seal and transfer it to the aFe airbox scoop (11). Reuse the 6 clips to attach the rubber seal to the scoop.



Figure F

Refer to Figure F for Steps 8-9

Step 8: Remove the retaining plug (12) from the bottom of the factory airbox and transfer it to the aFe airbox.

Step 9: Install the trim seal (13) on the opening of the aFe airbox.



Figure G

Refer to Figure G for Step 10

Step 10: Install the supplied large clamp (14) on the airbox then Slide the aFe filter and clamp (15) into the airbox. Do not tighten the clamps at this time.



Figure H

Refer to Figure H for Step 11

Step 11: Install the aFe airbox assembly into the vehicle. Firmly push it into the factory mounting grommets.

REMOVAL

INSTALL



Figure I

Refer to Figure I for Steps 12-13

Step 12: Remove the MAF sensor with gasket (16) from the factory airbox using a T20 Torx drive.

Step 13: Install the MAF sensor with gasket into the aFe intake tube using the supplied M4 screws and a T20 Torx drive.

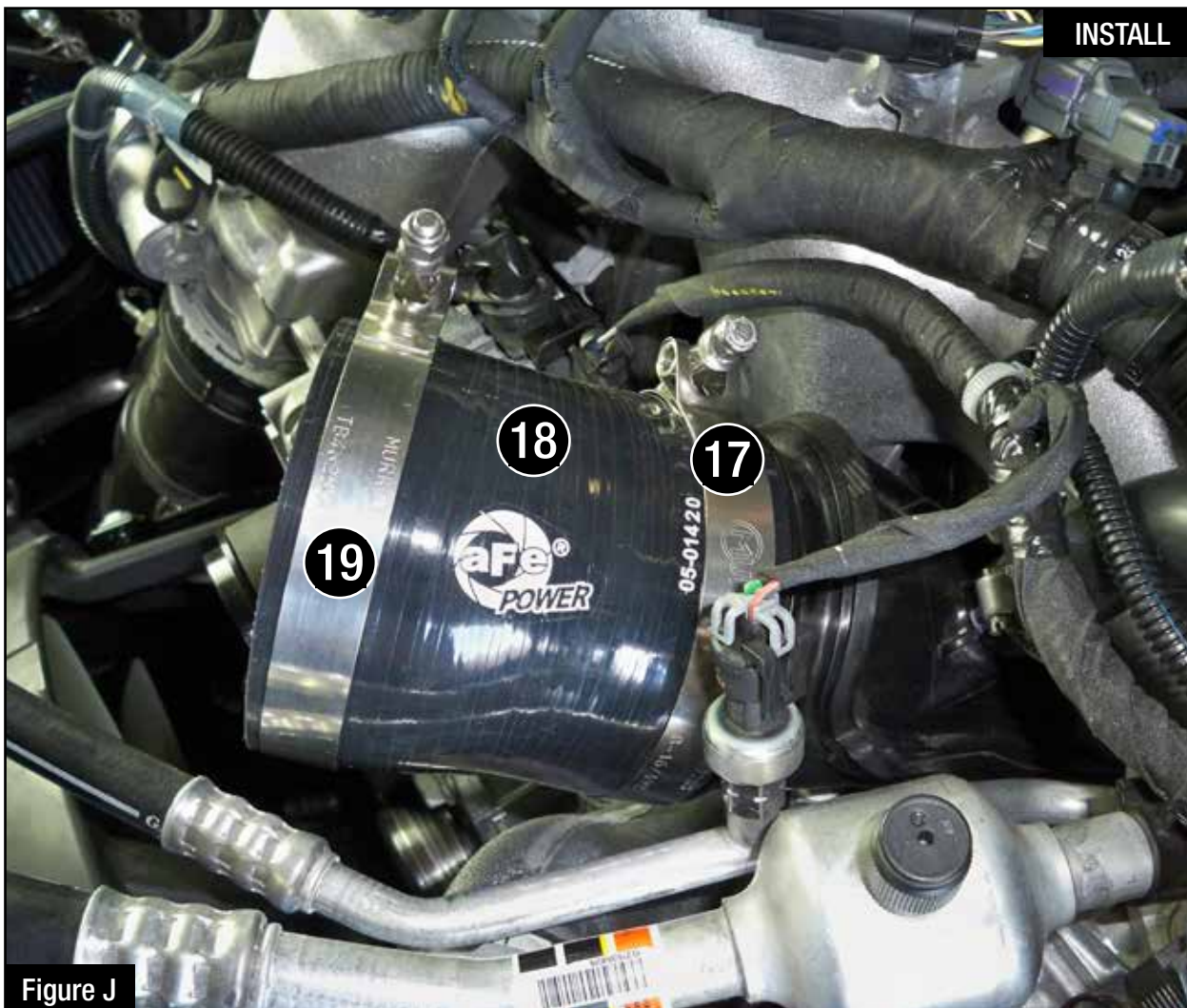

Figure J

Refer to Figure J for Step 14

Step 14: If the resonator is removed, install the supplied small clamp (17), coupler (18) and large clamp. (19)



Figure K

Refer to Figure K for Steps 15-16

Step 15: Slide the intake tube into the filter and then into the coupler.

Step 16: Align the intake tube correctly then tighten all clamps.



Figure L

Refer to Figure L for Steps 17-19

Step 17: Install scoop with the rubber seal (20) on top of the airbox.

Step 18: Reconnect the MAF sensor harness. (21)

Step 19: Make sure all clamps and connections are secured. Your installation is now complete! Thank you for choosing aFe POWER.

NOTE: Check all bolts, clamps, and connectors after 200 miles.



PAGE LEFT BLANK INTENTIONALLY

PAGE LEFT BLANK INTENTIONALLY



Pro DRY S Air Filter



P/N: 21-91059

Pro 5R Air Filter



P/N: 20-91059

Pro DRY S Restore Kit



P/N: 90-59999

Blue Squeeze Restore Kit



P/N: 90-50501

Blue Aerosol Restore Kit



P/N: 90-50001

Rebel XD Series Exhaust



P/N: 49-44089-B (Blk. Tips)
49-44089-P (Pol. Tips)

Downpipe Back Exhaust



P/N: 49-44087-B (Blk. Tip)
49-44087-P (Pol. Tip)

DPF-Back Exhaust



P/N: 49-44085-B (Blk. Tip)
49-44085-P (Pol. Tip)

Sprint Booster V3.



P/N: 77-14003

DFS Fuel System



P/N: 42-14023 (Full-Time)
42-14024 (Part-Time)

SCORCHER HD Module



P/N: 77-44010

Rear Differential Cover



P/N: 46-70012-WL (w/ Oil)

To purchase any of the items above, view airflow charts, dyno graphs, photos, and video; please go to aFepower.com.

Warranty

General Terms:

- aFe warrants their products to be free from manufacturer's defects due to workmanship and material.
- This warranty applies only to the original purchaser of the product and is non-transferrable.
- Proof of purchase of the aFe product is required for all warranty claims.
- Warranty is valid provided aFe instructions for installation and/or cleaning were properly followed.
- Proper maintenance with regular inspections of product is required to insure warranty coverage.
- Damage due to improper installation, abuse, unauthorized repair or alteration is not warranted.
- Incidental or consequential damages or cost, including installation and removal of part, incurred due to failure of aFe product is not covered under this warranty.
- All warranty is limited to the repair and/or replacement of the aFe part. To request Return Goods Authorization ("RGA"), email RGA@afepower.com or call (951)493-7100. Upon receipt of the RGA, you must return the product to the address provided in the RGA, freight prepaid and accompanied with a dated proof of purchase and the RGA. Upon receipt of the defective product and upon verification of proof of purchase, aFe will either repair or replace the defective product within a reasonable time, not to exceed thirty days.

Product Category	P/N Prefix	Warranty duration
Direct OE Replacement Filters	10, 11, 30, 31, 71, 73	Life of the vehicle
Racing Filters	18	1 year
Universal	21, 24, 72	2 years
Air Intake Systems	50, 51, 54, 55, 75	2 years
Exhaust Systems	49	2 years
Intercoolers & Intercooler Tubes	46-2	2 years
Intake Manifolds	46-1	2 years
Differential Cover	46-7	Life of the vehicle
Exhaust Manifolds	46	2 years
Throttle Body Spacers	46-3	2 years
Fluid Filters	44	90 days
Pre-Filters	28	2 years
Heavy Duty OE Replacement	70	2 years
PowerSports OE Replacement	81, 87	2 years
PowerSports Intake Systems	85	2 years

No other warranty expressed or implied applies nor is any person or advanced FLOW engineering authorized to assume any other warranty. Some States do not allow the exclusion or limitation of incidental or consequential damages or do not allow limitations on how long an implied warranty lasts, so the above limitations or exclusions may not apply to you. This warranty gives you specific legal rights, and you may also have other rights which vary from State to State.

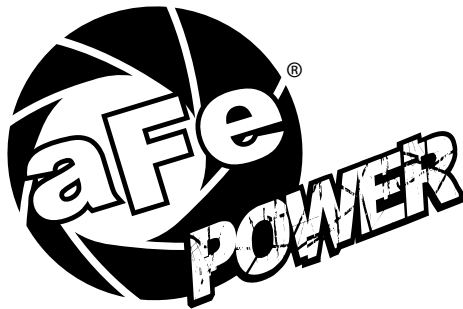

advanced FLOW engineering, inc.
252 Granite Street Corona, CA 92879
TEL: 951.493.7100 • TECH: 951.493.7134
E-Mail: Tech@aFepower.com