

Ford High Idle Kit

***2003-2004 Ford 6.0L Diesel
(Automatic transmission Only)***

1036609

PLEASE READ ALL INSTRUCTIONS BEFORE INSTALLATION

BD Engine Brake Inc.
Plant Address: 33541 MacLure Rd. Abbotsford, BC, Canada V2S 7W2
U.S. Shipping Address: 88-446 Harrison St, Sumas, WA 98295 U.S. Mailing Address: P.O. Box 231, Sumas, WA 98295
Phone: 604-853-6096 | Fax: 604-853-8749 | Internet: www.bd-power.com

About This Product

This high idle kit connects to the vehicles power takeoff wiring to enable the high idle feature. When active the engine will idle up to 1200RPM.

This is ideal for faster engine warm-ups, extended idling, some forms of power take-off equipment and running high demand electrical devices which require maximum charging capability. For safety, the vehicle should be in park with the parking brake applied before activating this feature.

If higher or variable engine RPM is required for a 2003-2004 Power Stroke, the customer must instead purchase a Ford APCM/AIC module from their Ford dealership.

Note: This kit may also be used on 1999-2002 Ford 7.3L Power Stroke diesel pickups that were ordered with the power take off provision. Be aware that the light blue with yellow trace wire may exist in the harness but will not be enabled on 7.3L Power Stroke vehicles without the power take off provision option code.

Tools Required

- Flat blade screwdriver
- Wire stripper and cutter
- Drill
- 1/2" Drill bit

BD Engine Brake Inc.

Plant Address: 33541 MacLure Rd. Abbotsford, BC, Canada V2S 7W2

U.S. Shipping Address: 88-446 Harrison St, Sumas, WA 98295 U.S. Mailing Address: P.O. Box 231, Sumas, WA 98295

Phone: 604-853-6096 | Fax: 604-853-8749 | Internet: www.bd-power.com

KIT CONTENTS:





Please check to make sure that you have all the parts listed in this kit **before** you start the disassembly of your truck.

1036609 Kit Contents

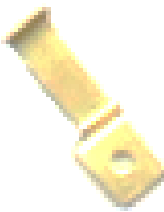

Switch Harness

Qty: 1

1300337	1300285	1300131	1003332
			
<i>Fuse Tapper</i>	<i>Blue Posi Lock</i>	<i>Tie Wrap (Medium)</i>	<i>Switch Decal</i>
Qty: 1	Qty: 1	Qty: 6	Qty: 1

INSTALLATION

VEHICLE SHOULD BE SAFELY SECURED BEFORE INSTALLATION.

1. Remove knee bolster below the steering column.



2. Determine a location to install the switch. Ensure there is sufficient room behind the panel for the switch and ensure the drill-bit will not damage any hidden wiring or other items behind the panel.

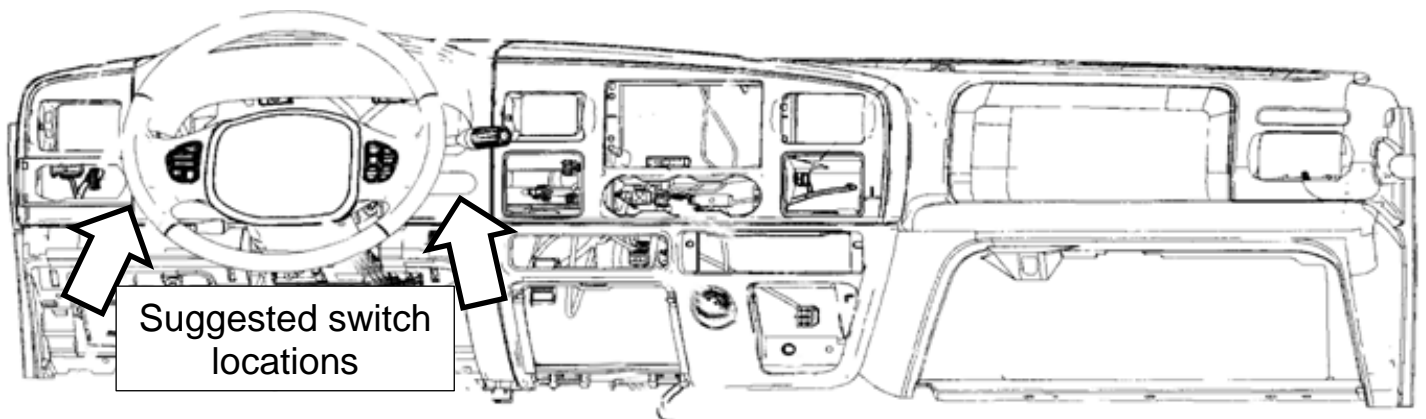

3. Install the switch through the dash panel and route wires towards the fuse panel.

4. Below the dash, follow the middle bulkhead wire from the firewall up and behind the fuse box. This is where you will find the customer access circuit wires. The wires will be taped to the top side of the harness.

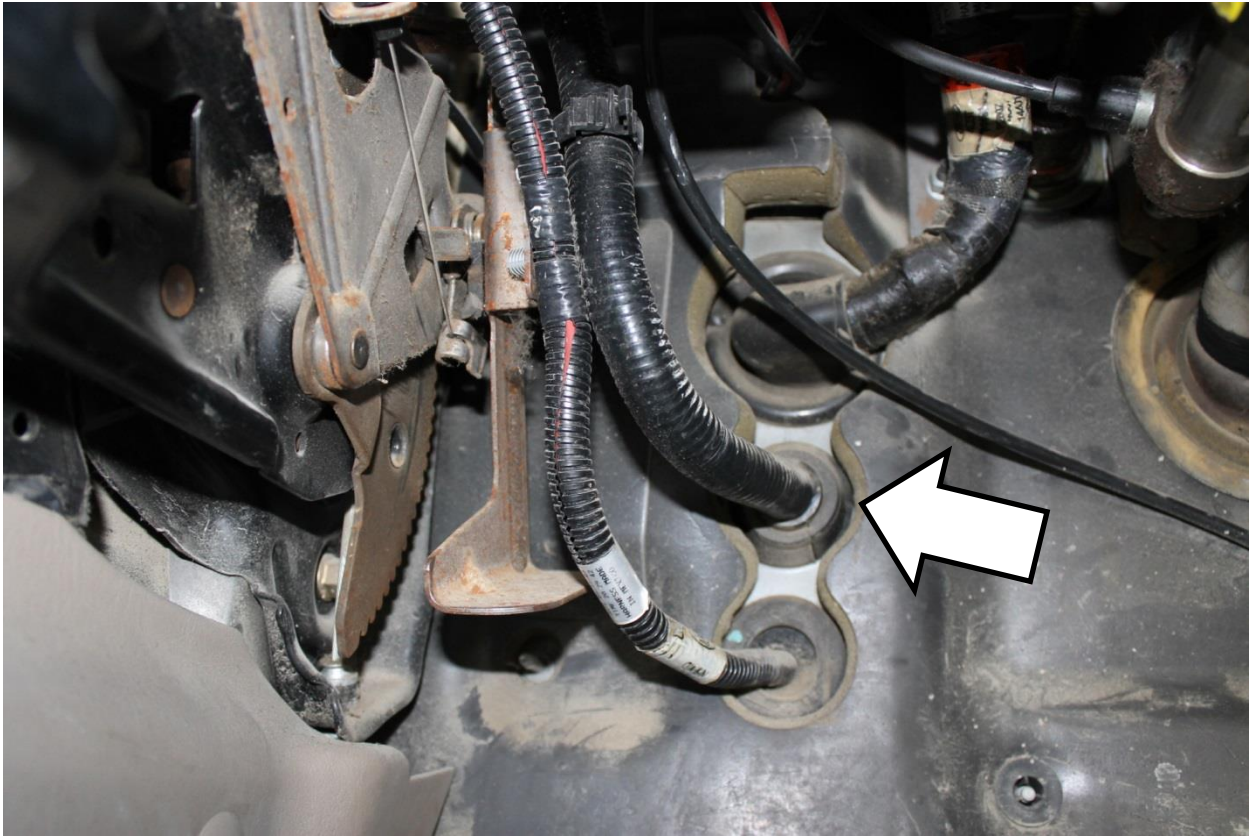

5. Locate the light blue wire with a yellow tracer and pull it downwards for better access.

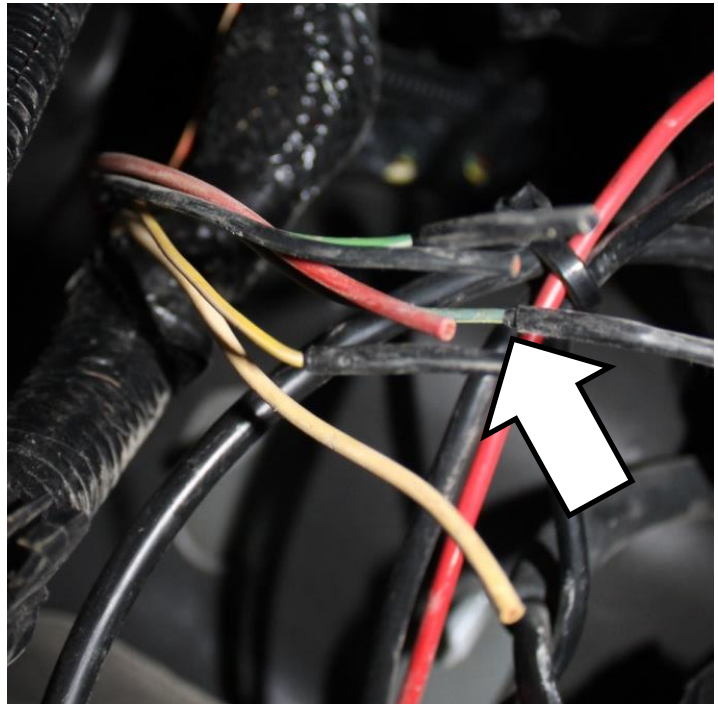

BD ENGINE BRAKE, INC.

Plant Address: A10-33733 King Rd, Abbotsford, BC, Canada V2S 7M9

US Shipping Address: 88-446 Harrison St, Sumas, WA 98295 US Mailing Address: PO Box 231, Sumas, WA 98295

Phone: 604-853-6096 Fax: 604-853-8749 Internet: www.bd-power.com

6. Cut the heat shrink off of the end of this wire, strip and install supplied posi-lock connector. Connect to the light blue wire from the kit.

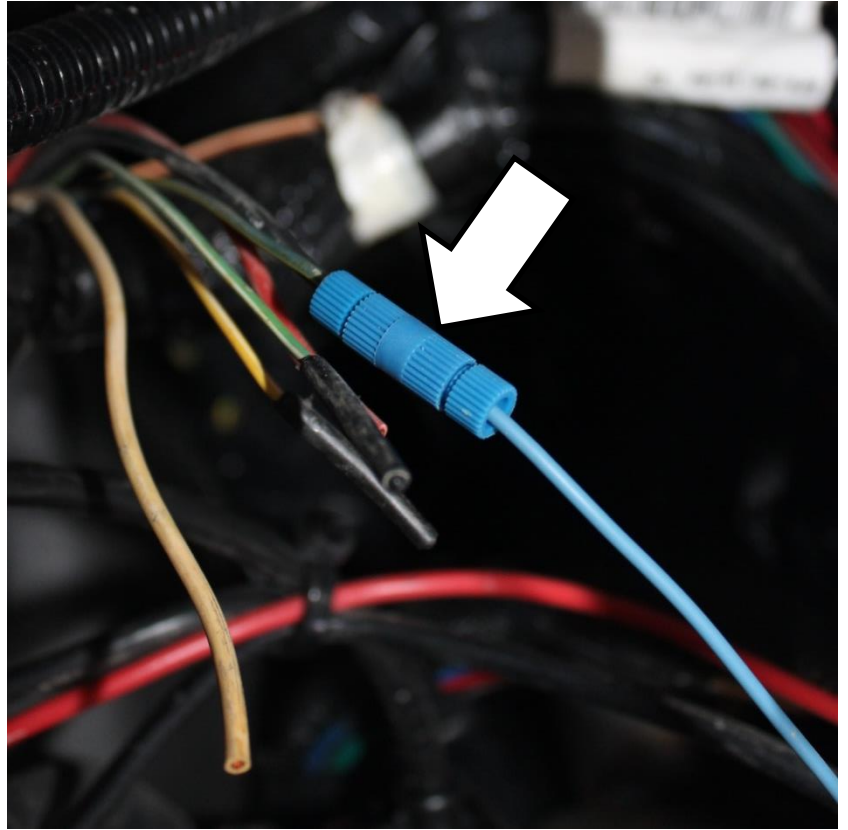

7. Connect the black wire to a ground using the supplied ring terminal. There are ground screws to the right, below the steering column.

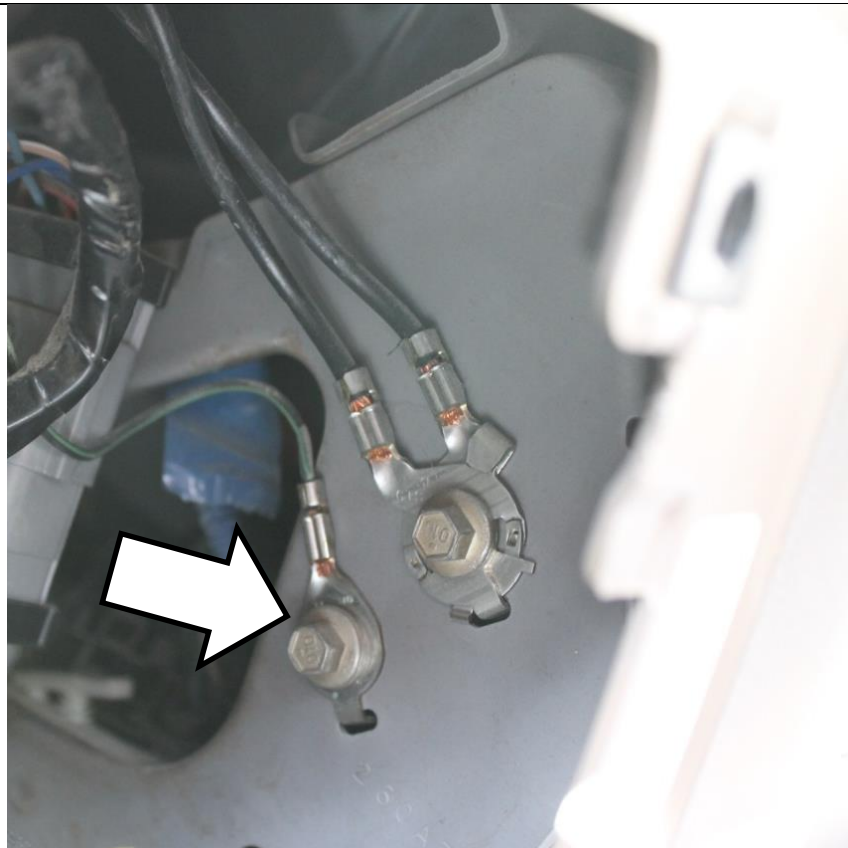

BD ENGINE BRAKE, INC.

Plant Address: A10-33733 King Rd, Abbotsford, BC, Canada V2S 7M9

US Shipping Address: 88-446 Harrison St, Sumas, WA 98295 US Mailing Address: PO Box 231, Sumas, WA 98295

Phone: 604-853-6096 Fax: 604-853-8749 Internet: www.bd-power.com

8. Remove the cover from the fuse panel and locate fuse number F2.45

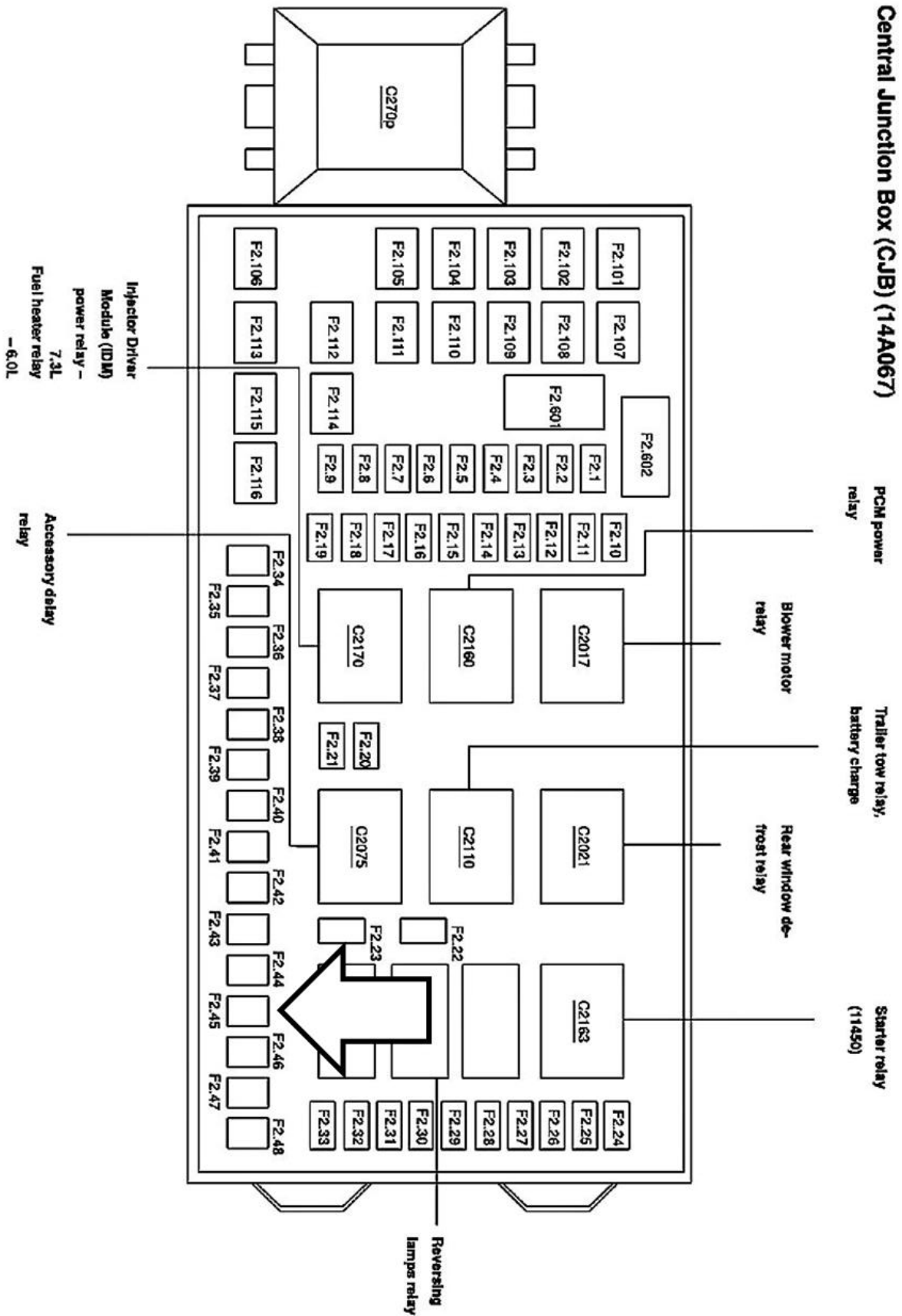

9. Remove the fuse and install the supplied fuse tap. Re-install fuse with the fuse tap on the top side. Connect the red wire from the high idle kit to this fuse tap.

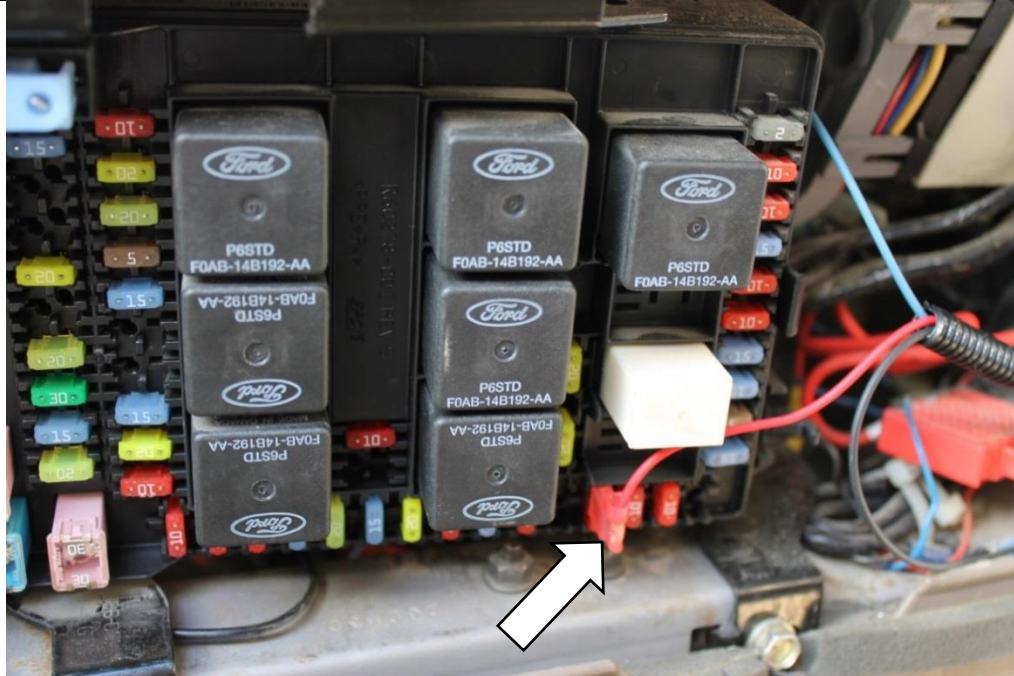

10. Use supplied wire ties to secure wiring behind dashboard.

11. Reinstall knee bolster panel and any other panels removed during installation.

12. Confirm function by starting engine. Ensure vehicle is in park and apply parking brake for safety. Turn switch to ON position. Switch should illuminate and the engine should gradually increase idle speed to 1200RPM. High idle will be temporarily disabled any time the brake pedal is pressed.

